



LENS CATALOGUE



GinoOptical

Standard

- Back side progressive design
- Budget solution for general daily use

Far	
Near	
Comfort	
Corridor length [mm]	12/14/16
Minimum fitting height [mm]	16/18/20

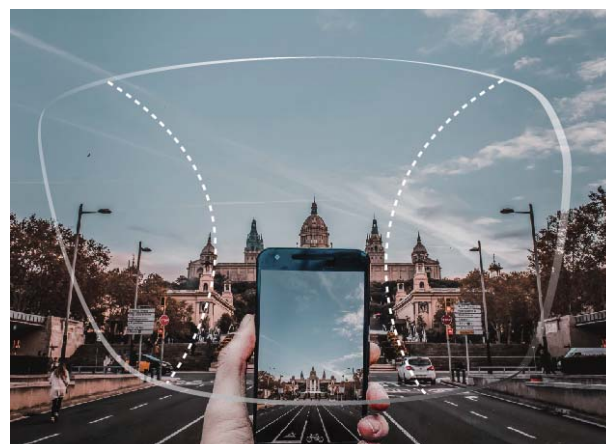

EasyFit

- Easy adaption
- Specifically designed for modern working places

Far	
Near	
Comfort	
Personalization	✓
Corridor length [mm]	12 – 16
Minimum fitting height [mm]	16 – 20



Dynamic

- Wide and clear distance vision
- Compatible with sports frames
- Designed for active wearer

Far	
Near	
Comfort	
Personalization	✓
Corridor length [mm]	12 – 16
Minimum fitting height [mm]	16 – 20

MiniFit

- Short corridor progressive lens engineered for extremely small frame

Far	
Near	
Comfort	
Corridor length [mm]	10
Minimum fitting height [mm]	14

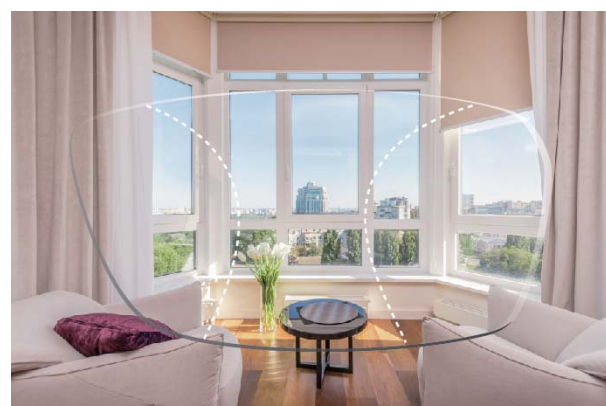

Compo

- Superior balance between the reading utility of the near zone and the dynamic vision utility of the distance and intermediate zones
- Allowing the wearer to perform different types of task with equal comfort

Far	
Near	
Comfort	
Personalization	✓
Corridor length [mm]	12 – 16
Minimum fitting height [mm]	16 – 20



Nature

- Custom-made for today's lifestyle
- Offers a really natural vision for all areas and a comfortable change between near and far vision
- Variable inset (0-5mm) improves the near visual field

Far	
Near	
Comfort	
Personalization	✓
Frame shape	Optimized
Corridor length [mm]	10 – 16
Minimum fitting height [mm]	14 – 20



Reader

- For all presbyopes who work more than 2-3 hours per day in front of computer.
- For people who perform visually intensive indoor activities such as reading, doing handicrafts.

Far	
Near	
Comfort	
Corridor length [mm]	12
Minimum fitting height [mm]	16

EzDrive

- Wide fields of vision in the far and intermediate zones.
- Easy focus switching between street, dashboard, navigation system and side mirrors.

Far	
Near	
Comfort	
Personalization	✓
Corridor length [mm]	12 – 16
Minimum fitting height [mm]	16 – 20



INFORMATIONS



Dual-side lens technology delivers a customized natural-viewing experience

The OptiMaxer DS dual surface progressive lens design features a unique variable front surface base curve - a surface innovation that provides the optically ideal base curve across all viewing zones.

The front surface, unlike most other free-form designs, is not spherical but has a unique variable front surface base curve that continually increases in vertical direction.

This front surface innovation provides benefits to wearers in both the distance and near zones. Wearers enjoy noticeably increased acuity in the periphery of the distance zone, as well as a reading area that is wider and more comfortable.

The HD inner compensation calculation creates a customized lens optimized for the wearer's prescription and frame selection.

Binocular Harmonization Technology	Position of Wear	Dual Surface Design	Thinner and Lighter	Extended Visual Fields	Optimized Design on frame shape



OptiMaxerDS



Traditional Progressive

Design Benefits:

- ▶ Increases clarity in the peripheral area of the lens and reduces distortion to the lens edge
- ▶ Noticeably more relaxed vision thanks to precise and effortless focusing
- ▶ Lens thickness reduced for a thinner, lighter and more cosmetically-appealing lens

Design Features:

- ▶ Digital Dual-Side Progressive Lens Design
- ▶ 6 Corridor Lengths: 10-15mm
- ▶ Uniform addition on the front surface, counterbalanced on the back to achieve the total addition power
- ▶ Clear, natural vision in all directions and at all distances
- ▶ Dramatically reduces swimming sensations

FreZZ The Freeform Personalization

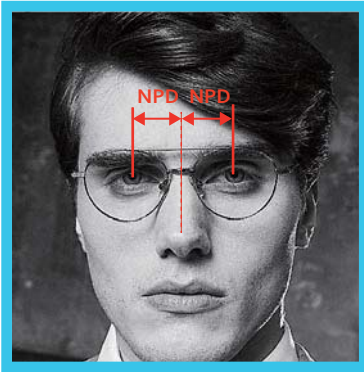

MONOCULAR PUPILLARY DISTANCE



BACK VERTEX DISTANCE

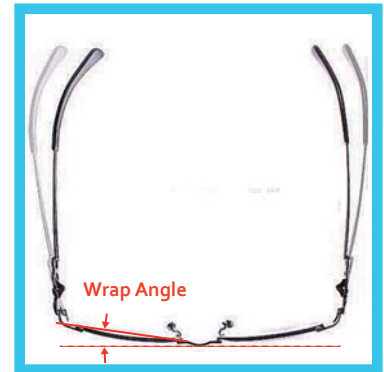

WRAP ANGLE
FRAME CURVATURE



PUPILAR HEIGHT



PANTOSCOPIC TILT



PUPILAR HEIGHT

What are the patient benefits of personalization?

- Personalized lens for every wearer
- Optimization based on the prescription for each position of wear
- Clearer, wider, more comfortable near vision
- Better visual performance: better contrast, wider fields of vision, easier vision

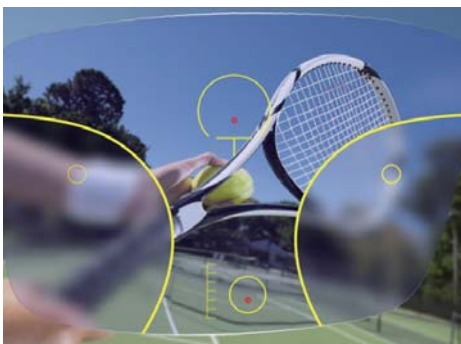

Without Personalization

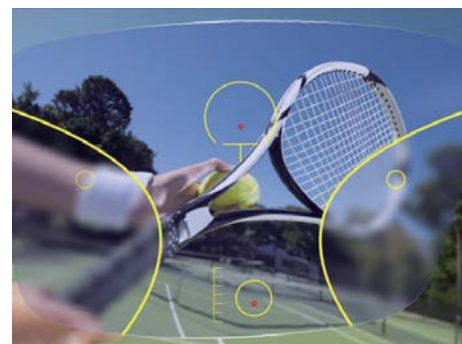

With Personalization

My SV

The aberrations and distortion are reduced to a greater degree on My SV lens

- Maximum optical quality for any prescription
- Thinner and lighter lenses
- High precision and high personalization
- Clear vision in every gaze direction
- Oblique astigmatism reduced

Point-by-point optimization is applied over the entire lens, leading to fewer power errors in the lens periphery and allows precise optical images.

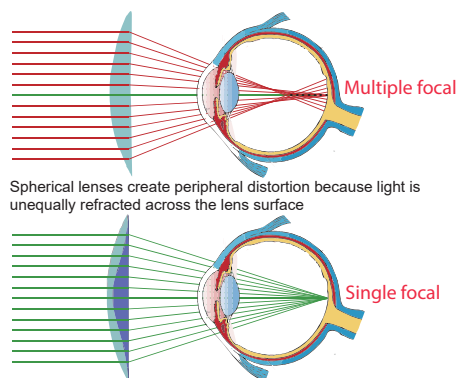

Spherical lenses create peripheral distortion because light is unequally refracted across the lens surface

Aspheric/Atoric lenses use multiple curvatures to reduce peripheral defocus and aberration

Anti-Fatigue SV

Anti-fatigue SV is designed primarily for 18-45 year old myopes experiencing symptoms of tired eyes because of their jobs or hobbies

- A slight addition power in the lower portion of the lens to reduce eyestrain during close up activities.
- Greater comfort than standard vision correction lenses because the wearers' natural accommodation pattern is retained.



EzDrive SV

- Improving comfort of night driving by Incorporating a night vision zone in the upper part of the lens.
- Optimized vision for a better view of the dashboard, internal, and external mirrors.



Bifocal Meta

The near vision segment is expanded up to the entire half area, offering a noticeably larger near viewing area while maintaining panoramic distance vision.



Bifocal Freeround

The near vision segment is very similar to a conventional round top bifocal. This solution is perfect for those who already wear bifocal lenses and want better aesthetics.





**MOOFX IS AN INNOVATIVE SPECTACLE LENS
WE MUST START A MYOPIA MANAGEMENT RIGHT NOW**



Full-field
Clear vision



Easy to adapt with
myopia control area



Available in
blue cut material

Acta Ophthalmologica, DOI: 10.1111/aos.15649

MYOPIA SOLUTION

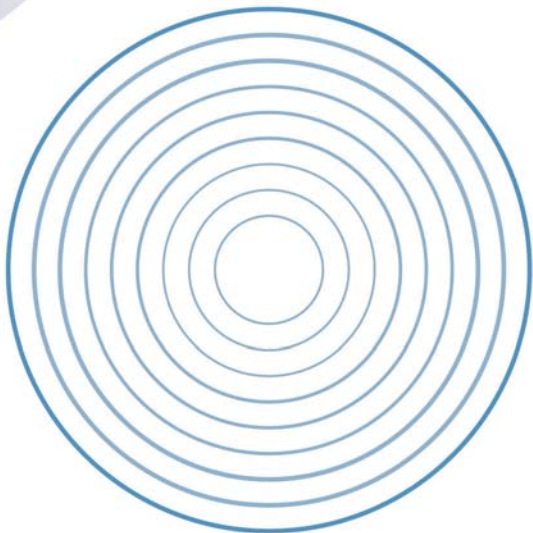

F.I.M.C.A. Technology

Fluctuation Induced by Micro-Cylindrical Annular

MOOFX

MYOPIA MANAGEMENT LENS

A cylindrical focal plan in front of the retina to induce dynamic defocus signal for myopia control

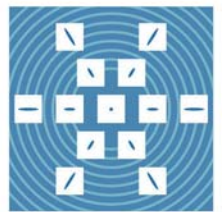
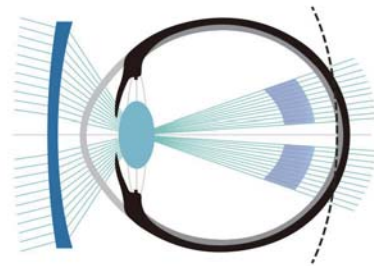
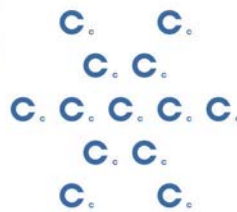

THEORY – PRACTICE – PATENT

By performing corneal topographies of the eye after wearing orthokeratology lenses, they realized that corneal astigmatism was distributed in concentric circles.

INFORMATIONS

Engraving of Gino Progressive lenses

Freeform Progressive

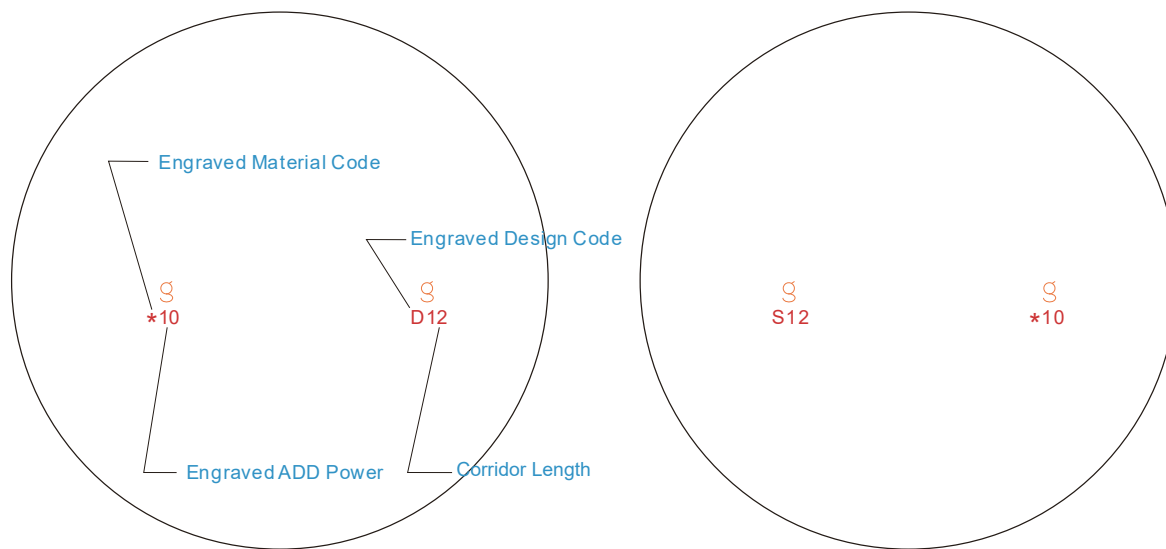

Temporal

Nasal

Temporal

Lens Material	Material Code
1.50	C
1.56	M
1.59	P
1.60	H
1.67	S
1.74	X

Lens Design	Design Code
Frezz Standard	P
Frezz EasiFit	E
Frezz Dynamic	D
Frezz Compo	C
Frezz Nature	NX
Frezz MiniFit	M
Frezz Reader	R
Frezz EzDrive	V
Frezz OptiMaxerDS	OMD

Conventional Progressive	Axial		Nasal Side	Temporal Side	Material	Index
	Layout		Design Code/Corridor	Addition/Index Key		
Vega HD Classic 1.5	○ ○		A1	175	Organic	1.5
Vega HD Short 1.5	○ ○		AS	175	Organic	1.5
Vega HD Classic 1.6	○ ○		A1	175	Organic	1.6

TREATMENTS

		BlueFreeK+	
		MultiK+	Blue Light Protection
	BlueFree	Back side UV protection	Back side UV protection
		Easy cleaning Superhydrophobic	Easy cleaning Superhydrophobic
		Antistatic	Antistatic
Multi	Blue Light Protection	AR layers	AR layers
AR layers	AR layers	Scratch resistant	Scratch resistant
Scratch resistant	Scratch resistant		

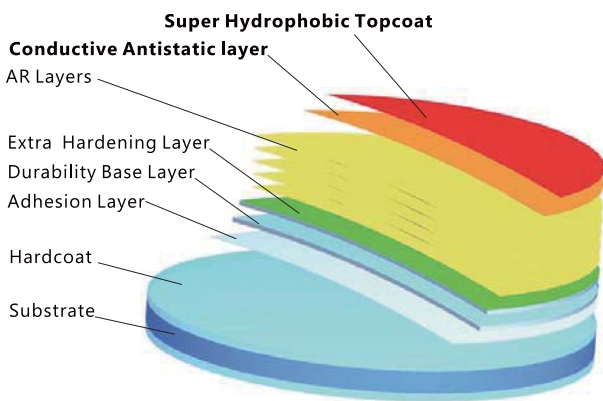

MultiK+

Clearer Vision And Easy Care

- ➔ Outstanding abrasion resistance.
- ➔ Super Hydrophobic layer increase the contact angle, that helps repel oil, water and smudge.
- ➔ Antistatic layer makes the lens free of dust.



SuperCleanCoat



Dust-Free



Optimum transparency



Scratch Resistant



Blue Cut for Digital Protection

As the widespread use of smart phones & tablets increases, people are exposed to more blue light today than ever before. Our digital devices emit strong blue light which scatters easily, reducing contrast and adding to eye fatigue.

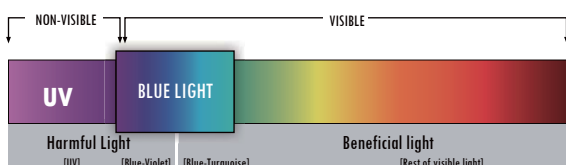

BlueFreeK+ is designed to block harmful blue-violet light whose wavelength ranges between 380 to 455 nm, keeping the eyes in better condition.



Solid solar tints

Wearing sunglasses is the guarantee of benefiting from tints that combine sun protection, comfort and aesthetics.

Grey

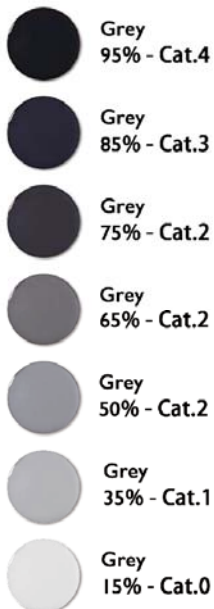

Brown

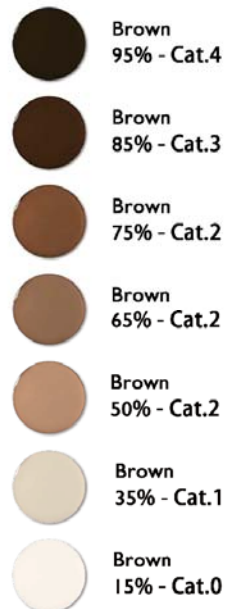

Pioneer (GRAY GREEN)

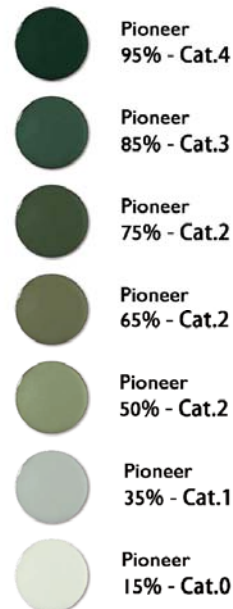

Pink

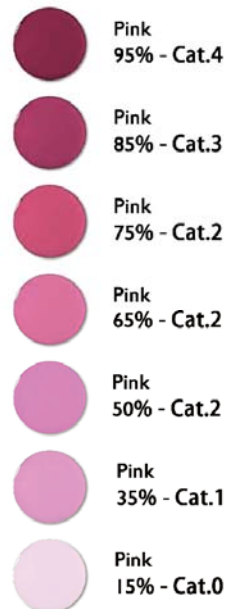

Blue

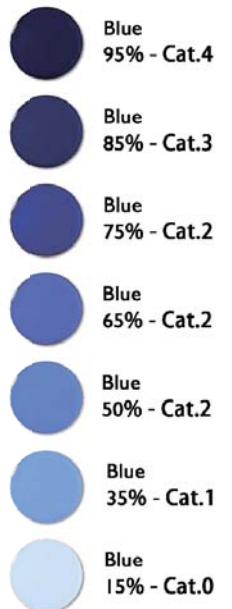

Solid shades on organic lenses

A complete range of solid shades on organic lenses up to 1.67.

Gradient tints on organic lenses

We offer a wide choice of tints and gradient intensities on organic lenses up to 1.67. You can choose a gradient that is purely aesthetic (25/0%) or highly protective (90/40%). Wearing gradient shades is the guarantee of wearing glasses that follow fashion and protect you from the sun.

Grey

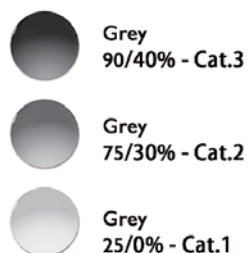

Brown

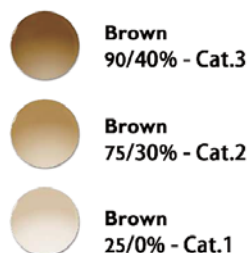

Pioneer (GRAY GREEN)

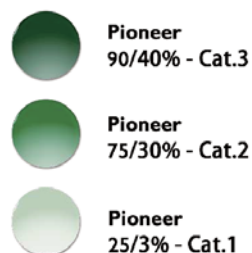

Pink

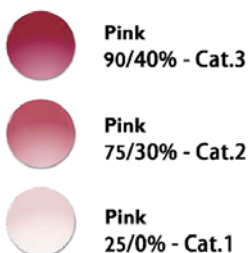

Blue

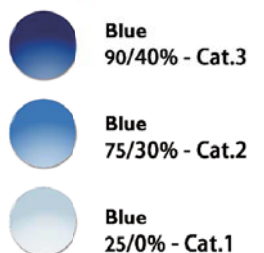

INFORMATIONS

NUPOLAR
polarized lenses

More Color Options



GRAY-3

Excellent for bright sun conditions while color integrity is maintained. Colors become richer and deeper and maximum blinding glare protection is provided.



BROWN

A true, deep, rich brown that provides for a wearing experience in which the lens enhances colors and especially highlights greens.



GREEN

Perfect for those who enjoy a traditional green color. It is preferred for the enhancement of colors.



Without Nupolar



With Nupolar



NUPOLAR GRADIENTS:
GRAY/GRAY, BROWN/GRAY



NUPOLAR MIRRORS:
SILVER, BLUE & GOLD

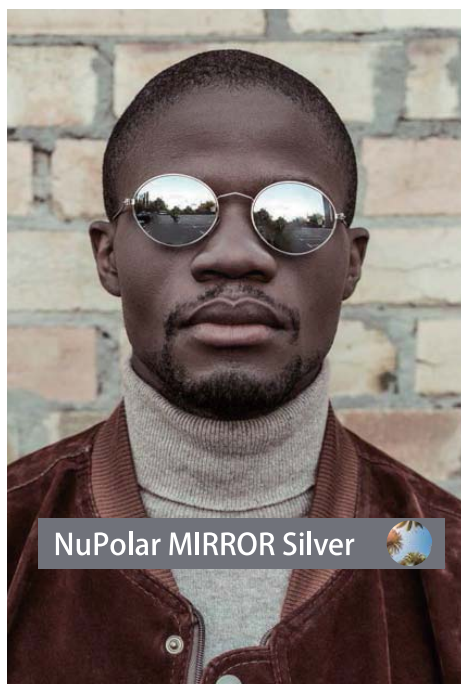

NuPolar MIRROR Silver



NuPolar MIRROR Blue



NuPolar MIRROR Gold

INFORMATIONS



The PhotoX Lens uses revolutionary technology to reconstruct photochromic molecules. It breaks the molecular structure differently and when exposed in ultraviolet light, molecules of PhotoX Lens start to change structure simultaneously, which greatly improve the responding speed. As a result, lens' color changes become faster and darker.



ATTRIBUTE	PHOTOX VS TRADITIONAL PHOTOCROMIC LENS
CHANGING SPEED	18.5% FASTER
DARKNESS	29.80% DARKER
FADING SPEED	26% FASTER

MORE COLORS ARE AVAILABLE TO FIT YOUR STYLE

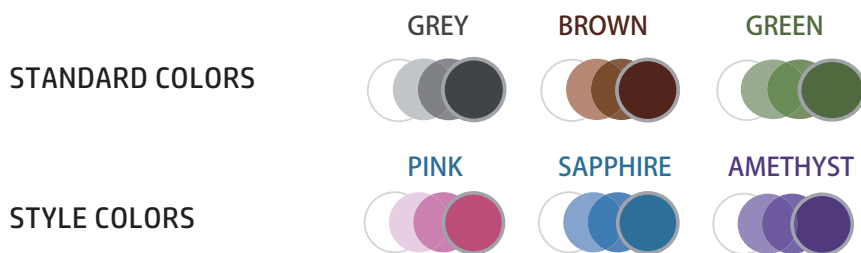

Clear Indoor
High clarity when indoor

Dark Outdoor
Dark enough when outdoor

Fast Reaction
Fast colour changing between indoor & outdoor

UV Protection
100% protection against UVB & UVA

Blue Light Block
Block blue light indoor & outdoor

INFORMATIONS



UV and Blue Block

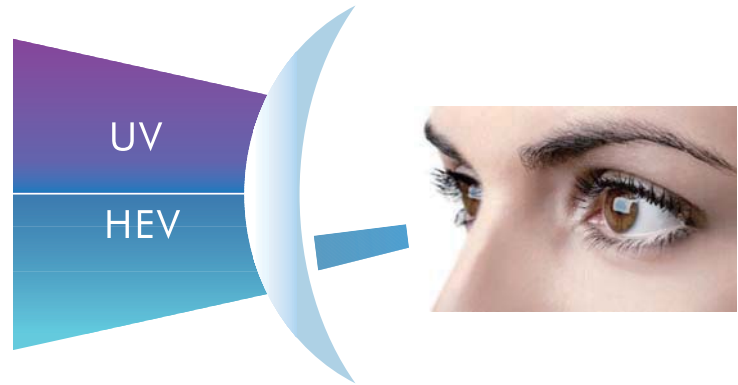

What is HEV light?

HEV light is high-frequency, high-energy light in the violet/blue band from 400 to 500 nm in the visible spectrum.

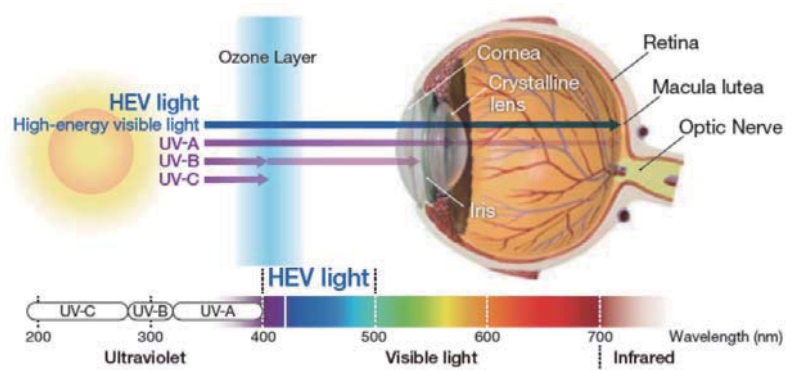

Why do we need HEV blocking

Short-wavelength light in the 400-420 nm spectrum has high energy. So it is more likely to pass through the cornea and lens and induce harmful reaction. Younger individuals (up to 20 years old) are at particular risk, because their eye lenses are especially transparent and they tend to participate in more outdoor activities.

What is UVNeo lens?

- Block harmful light in the 400-420 nm part of the spectrum in addition to UV
- Colors look natural even when 400-420 nm light is blocked

1.5 Stock SV

⊕ Refractive Index	1.499
⊕ Abbe Value	58
⊕ Specific Gravity (gr/cm3)	1.32
⊕ Coating	HC/Multi/Multi K+
⊕ Tints	Grey/Brown/G15
⊕ Spheric design organic	

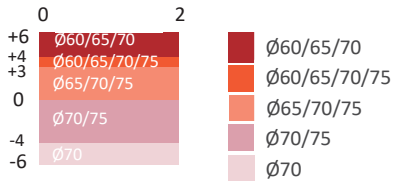

1.50 Polar Plano SV

⊕ Refractive Index	1.499
⊕ Abbe Value	58
⊕ Specific Gravity (gr/cm3)	1.32
⊕ Coating	HC
⊕ Tints	
⊕ Spheric design polar	Grey/Brown

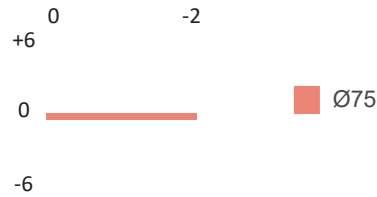

1.56 Stock SV

⊕ Refractive Index	1.56
⊕ Abbe Value	38
⊕ Specific Gravity (gr/cm3)	1.28
⊕ Coating	HC/Multi K+
⊕ Tints	Grey/Brown/G15
⊕ Spheric design organic	

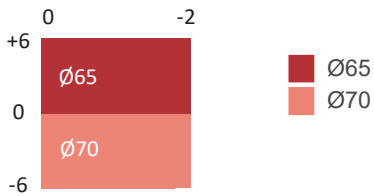

1.56 Photochromic Stock SV

⊕ Refractive Index	1.56
⊕ Abbe Value	38
⊕ Specific Gravity (gr/cm3)	1.28
⊕ Coating	Multi K+
⊕ Tints	
⊕ Spheric design photochromic	Grey/Brown

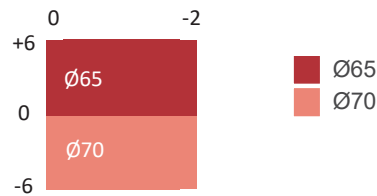

1.59 Polycarbonate Stock SV

⊕ Refractive Index	1.59
⊕ Abbe Value	38
⊕ Specific Gravity (gr/cm3)	1.28
⊕ Coating	Multi
⊕ Tints	Grey/Brown
⊕ Spheric design polycarbonate	

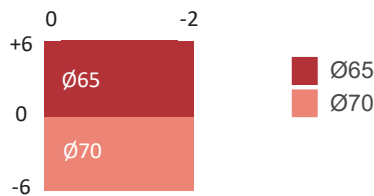

1.6 MR-8 Stock SV

⊕ Refractive Index	1.6
⊕ Abbe Value	42
⊕ Specific Gravity (gr/cm3)	1.30
⊕ Coating	Multi/Multi K+
⊕ Tints	Grey/Brown/G15
⊕ Spheric design organic	

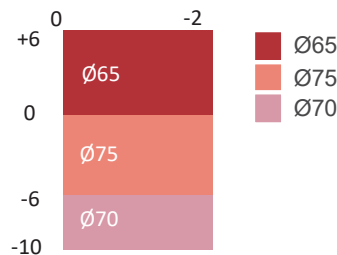

1.67 Stock SV

⊕ Refractive Index	1.67
⊕ Abbe Value	32
⊕ Specific Gravity (gr/cm3)	1.35
⊕ Coating	Multi
⊕ Tints	Grey/Brown/G15
⊕ Aspheric design organic	

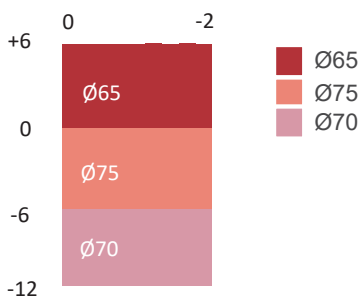

1.74 Stock SV

⊕ Refractive Index	1.67
⊕ Abbe Value	32
⊕ Specific Gravity (gr/cm3)	1.35
⊕ Coating	Multi
⊕ Tints	Grey/Brown/G15
⊕ Aspheric design organic	

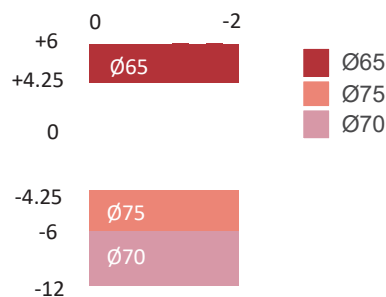

1.5 SV RX

⊕ Refractive Index	1.5
⊕ Abbe Value	58
⊕ Coating	HC/Multi/Multi K+/BlueFree
⊕ Tints	Grey/Brown/G15

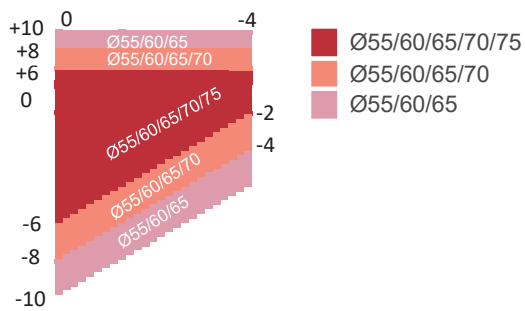

1.5 Nupolar SV RX

⊕ Refractive Index	1.5
⊕ Abbe Value	58
⊕ Coating	HC/Multi/Multi K+/BlueFree
⊕ Polarized Color	Grey/Brown/G15

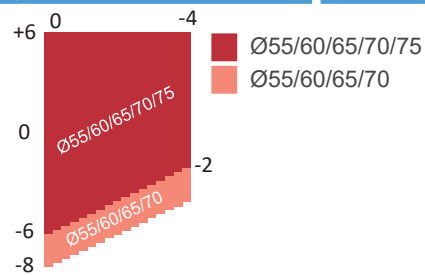

1.5 PhotoX SV RX

⊕ Refractive Index	1.5
⊕ Abbe Value	58
⊕ Coating	HC/Multi/Multi K+/BlueFree
⊕ Photochromic Color	Grey/Brown

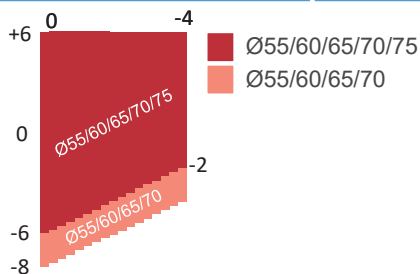

1.5 Transitions SV RX

⊕ Refractive Index	1.5
⊕ Abbe Value	58
⊕ Coating	HC/Multi/Multi K+/BlueFree
⊕ Photochromic Color	Grey/Brown

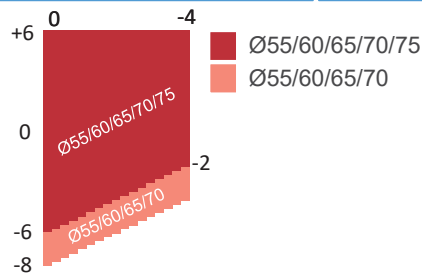

1.5 UVNeo SV RX

⊕ Refractive Index	1.5
⊕ Abbe Value	58
⊕ Coating	HC/Multi/Multi K+/BlueFree
⊕ Tints	

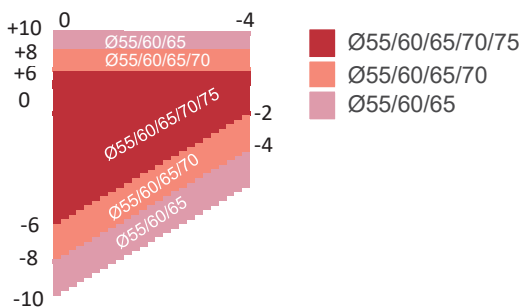

1.56 SV RX

⊕ Refractive Index	1.56
⊕ Abbe Value	38
⊕ Coating	HC/Multi/Multi K+/BlueFree
⊕ Tints	Grey/Brown/G15

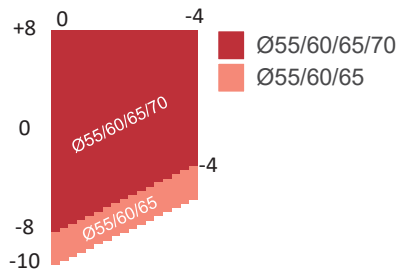

1.56 Photochromic SV RX

⊕ Refractive Index	1.6
⊕ Abbe Value	38
⊕ Coating	HC/Multi/Multi K+/BlueFree
⊕ Photochromic Color	Grey/Brown

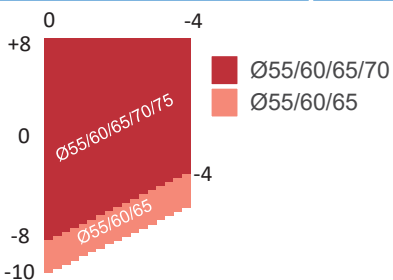

1.56 UVNeo SV RX

⊕ Refractive Index	1.56
⊕ Abbe Value	38
⊕ Coating	HC/Multi/Multi K+/BlueFree
⊕ Tints	

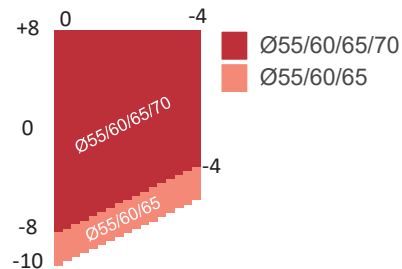

1.59 Polycarbonate SV RX

⊕ Refractive Index	1.59
⊕ Abbe Value	31
⊕ Coating	HC/Multi/Multi K+/BlueFree
⊕ Tints	

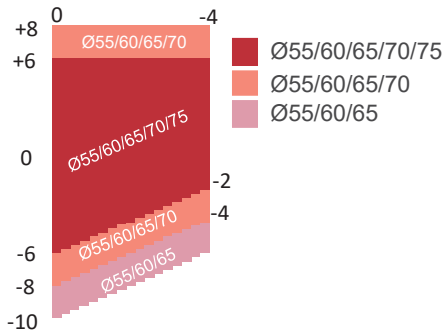

1.59 Poly PhotoX SV RX

⊕ Refractive Index	1.59
⊕ Abbe Value	31
⊕ Coating	HC/Multi/Multi K+/BlueFree
⊕ Photochromic Color	Grey/Brown

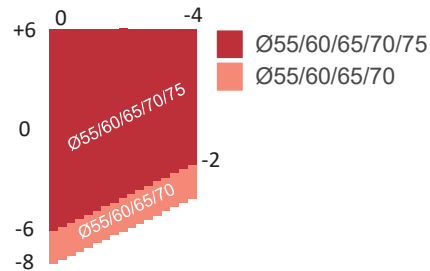

1.59 Poly Nupolar SV RX

⊕ Refractive Index	1.59
⊕ Abbe Value	31
⊕ Coating	HC/Multi/Multi K+/BlueFree
⊕ Polarized Color	Grey/Brown/G15

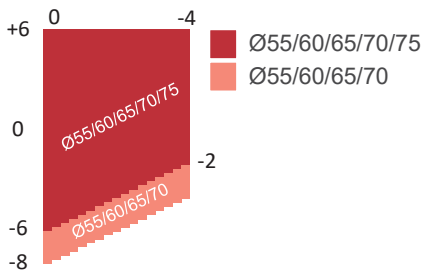

1.6 MR-8 SV RX

⊕ Refractive Index	1.6
⊕ Abbe Value	42
⊕ Coating	HC/Multi/Multi K+/BlueFree
⊕ Tints	Grey/Brown/G15

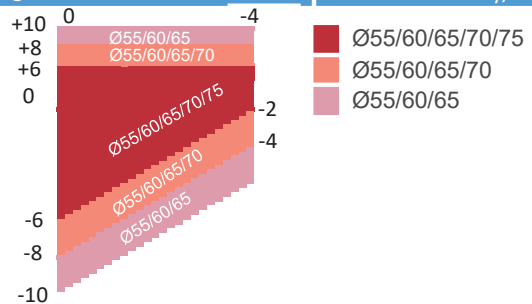

1.6 Nupolar SV RX

⊕ Refractive Index	1.61
⊕ Abbe Value	42
⊕ Coating	HC/Multi/Multi K+/BlueFree
⊕ Polarized Color	Grey/Brown/G15

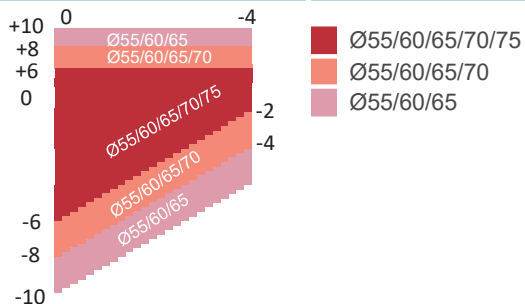

1.6 PhotoX SV RX

⊕ Refractive Index	1.61
⊕ Abbe Value	42
⊕ Coating	HC/Multi/Multi K+/BlueFree
⊕ Photochromic Color	Grey/Brown

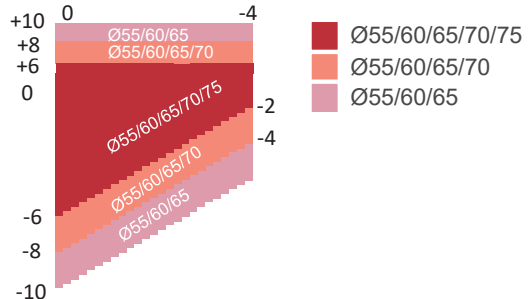

1.6 Transitions SV RX

⊕ Refractive Index	1.61
⊕ Abbe Value	42
⊕ Coating	HC/Multi/Multi K+/BlueFree
⊕ Photochromic Color	Grey/Brown

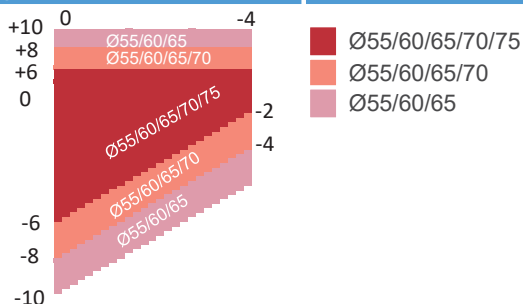

1.6 UVNeo SV RX

⊕ Refractive Index	1.61
⊕ Abbe Value	42
⊕ Coating	HC/Multi/Multi K+/BlueFree
⊕ Tints	

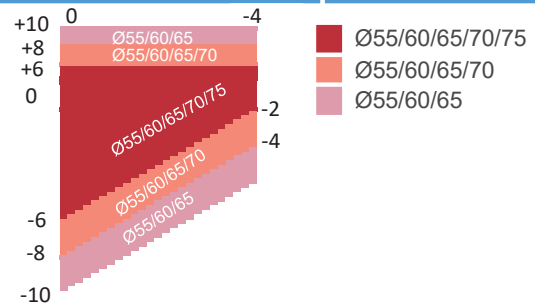

1.67 SV RX

⊕ Refractive Index	1.67
⊕ Abbe Value	32
⊕ Coating	HC/Multi/Multi K+/BlueFree
⊕ Tints	Grey/Brown/G15

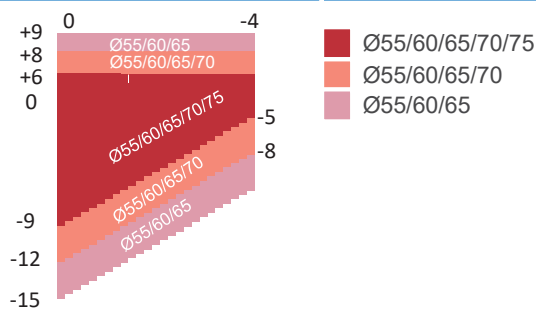

1.67 Nupolar SV RX

⊕ Refractive Index	1.67
⊕ Abbe Value	32
⊕ Coating	HC/Multi/Multi K+/BlueFree
⊕ Polarized Color	Grey/Brown/G15

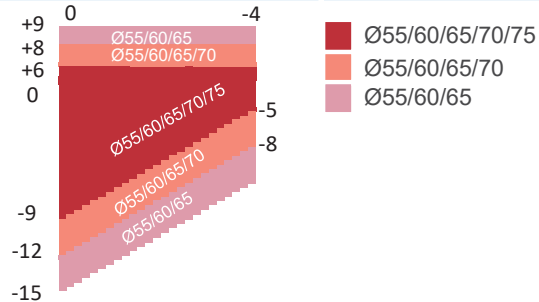

1.67 PhotoX SV RX

⊕ Refractive Index	1.67
⊕ Abbe Value	32
⊕ Coating	HC/Multi/Multi K+/BlueFree
⊕ Photochromic Color	Grey/Brown

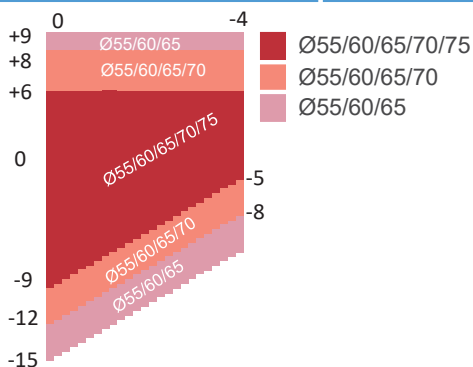

1.67 Transitions SV RX

⊕ Refractive Index	1.67
⊕ Abbe Value	32
⊕ Coating	HC/Multi/Multi K+/BlueFree
⊕ Photochromic Color	Grey/Brown

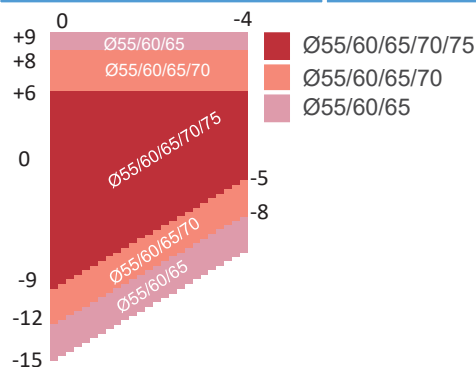

1.67 UVNeo SV RX

⊕ Refractive Index	1.67
⊕ Abbe Value	32
⊕ Coating	HC/Multi/Multi K+/BlueFree
⊕ Tints	

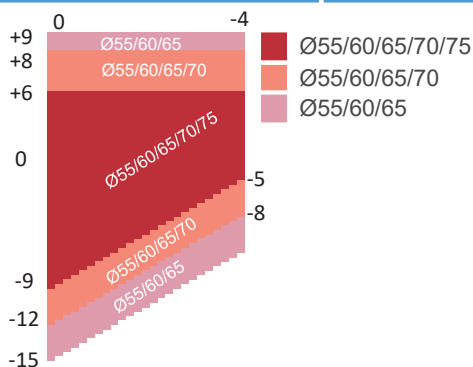

1.74 SV RX

⊕ Refractive Index	1.74
⊕ Abbe Value	32
⊕ Coating	Multi/Multi K+/BlueFree
⊕ Tints	

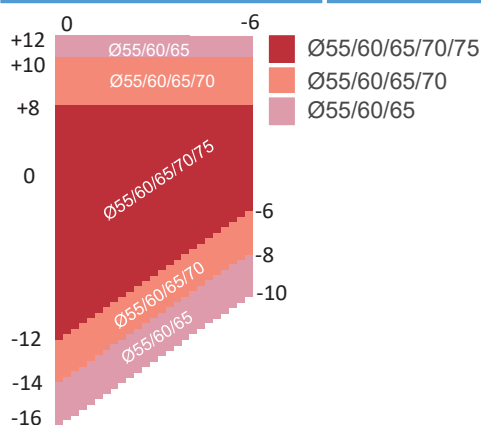

1.74 Transitions SV RX

⊕ Refractive Index	1.74
⊕ Abbe Value	32
⊕ Coating	Multi/Multi K+/BlueFree
⊕ Photochromic Color	Grey/Brown

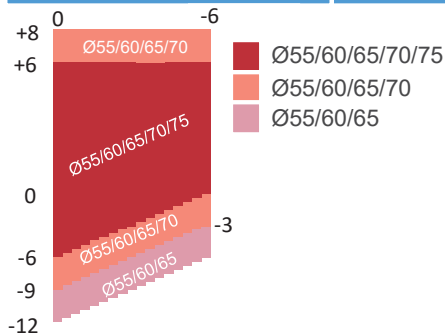

MY SV - Anti Fatigue SV - EzDrive SV

My SV 1.5

⊕ Refractive Index	1.5
⊕ Abbe Value	58
⊕ Coating	HC/Multi/Multi K+/BlueFree
⊕ Tints	Grey/Brown/G15

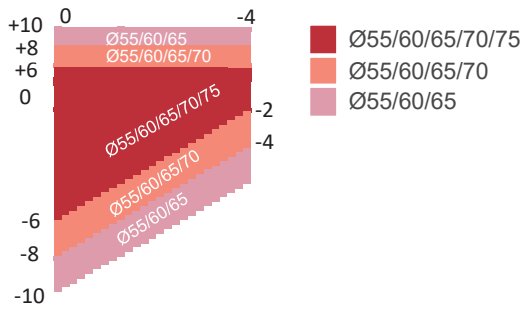

My SV 1.5 Nupolar

⊕ Refractive Index	1.5
⊕ Abbe Value	58
⊕ Coating	HC/Multi/Multi K+/BlueFree
⊕ Polarized Color	Grey/Brown/G15

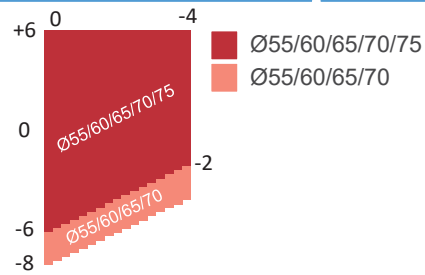

My SV 1.5 PhotoX

⊕ Refractive Index	1.5
⊕ Abbe Value	58
⊕ Coating	HC/Multi/Multi K+/BlueFree
⊕ Photochromic Color	Grey/Brown

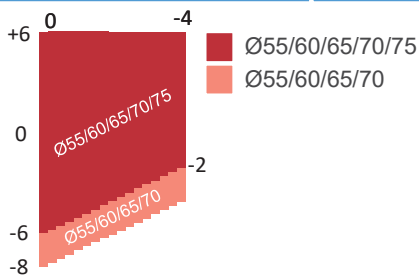

My SV 1.5 Transitions

⊕ Refractive Index	1.5
⊕ Abbe Value	58
⊕ Coating	HC/Multi/Multi K+/BlueFree
⊕ Photochromic Color	Grey/Brown

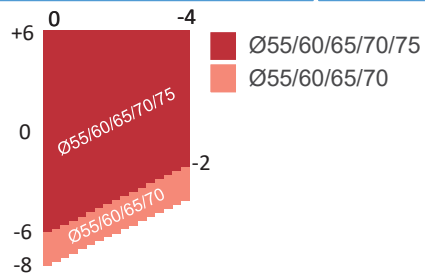

My SV 1.5 UVNeo

⊕ Refractive Index	1.5
⊕ Abbe Value	58
⊕ Coating	HC/Multi/Multi K+/BlueFree
⊕ Tints	

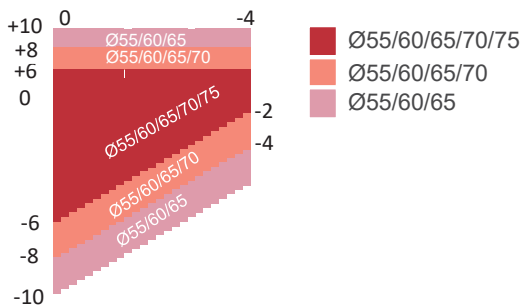

My SV 1.56

⊕ Refractive Index	1.56
⊕ Abbe Value	38
⊕ Coating	HC/Multi/Multi K+/BlueFree
⊕ Tints	Grey/Brown/G15

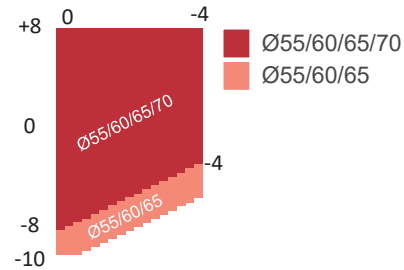

My SV 1.56 Photochromic

⊕ Refractive Index	1.6
⊕ Abbe Value	38
⊕ Coating	HC/Multi/Multi K+/BlueFree
⊕ Photochromic Color	Grey/Brown

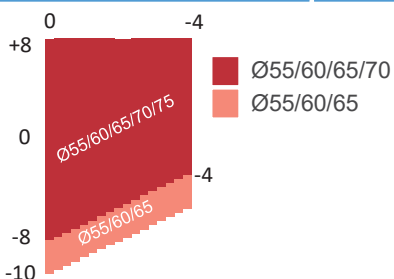

My SV 1.56 UVNeo

⊕ Refractive Index	1.56
⊕ Abbe Value	38
⊕ Coating	HC/Multi/Multi K+/BlueFree
⊕ Tints	

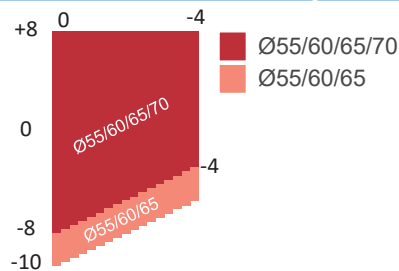

MY SV - Anti Fatigue SV - EzDrive SV

My SV 1.59 Polycarbonate

⊕ Refractive Index	1.59
⊕ Abbe Value	31
⊕ Coating	HC/Multi/Multi K+/BlueFree
⊕ Tints	

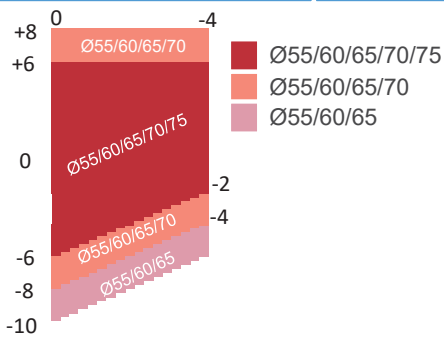

My SV 1.59 Poly PhotoX

⊕ Refractive Index	1.59
⊕ Abbe Value	31
⊕ Coating	HC/Multi/Multi K+/BlueFree
⊕ Photochromic Color	Grey/Brown

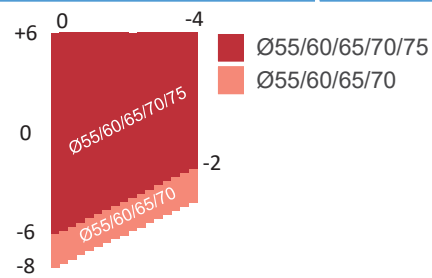

My SV 1.59 Poly Nupolar

⊕ Refractive Index	1.59
⊕ Abbe Value	31
⊕ Coating	HC/Multi/Multi K+/BlueFree
⊕ Polarized Color	Grey/Brown/G15

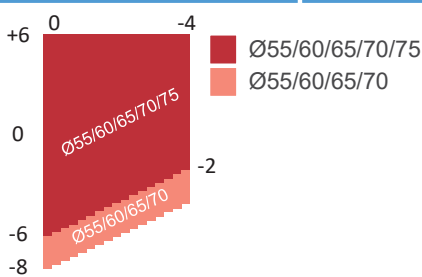

My SV 1.6 MR-8

⊕ Refractive Index	1.6
⊕ Abbe Value	42
⊕ Coating	HC/Multi/Multi K+/BlueFree
⊕ Tints	Grey/Brown/G15

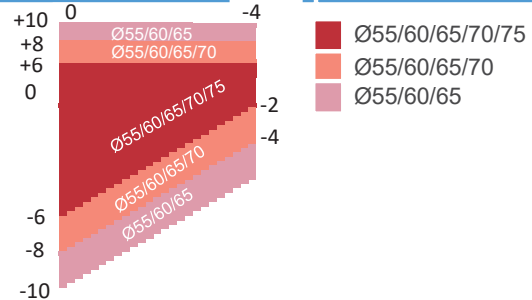

My SV 1.6 Nupolar

⊕ Refractive Index	1.61
⊕ Abbe Value	42
⊕ Coating	HC/Multi/Multi K+/BlueFree
⊕ Polarized Color	Grey/Brown/G15

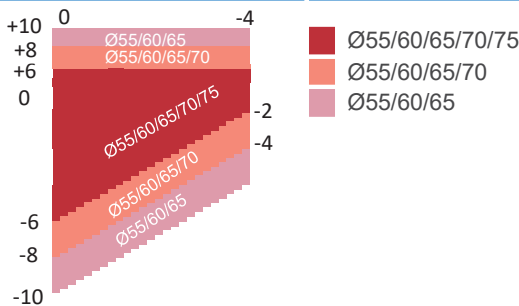

My SV 1.6 PhotoX

⊕ Refractive Index	1.61
⊕ Abbe Value	42
⊕ Coating	HC/Multi/Multi K+/BlueFree
⊕ Photochromic Color	Grey/Brown

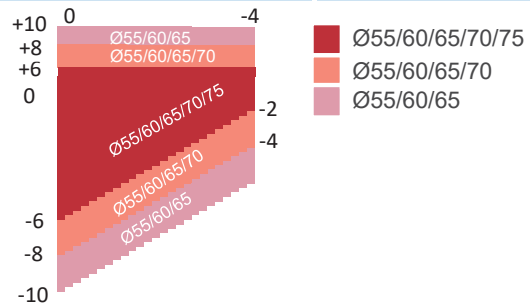

My SV 1.6 Transitions

⊕ Refractive Index	1.61
⊕ Abbe Value	42
⊕ Coating	HC/Multi/Multi K+/BlueFree
⊕ Photochromic Color	Grey/Brown

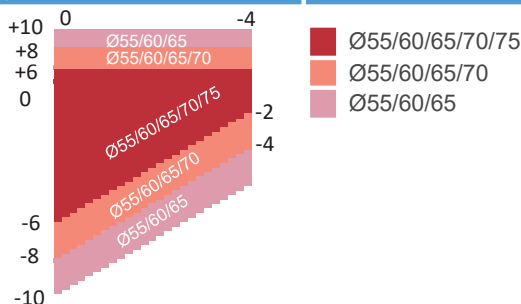

My SV 1.6 UVNeo

⊕ Refractive Index	1.61
⊕ Abbe Value	42
⊕ Coating	HC/Multi/Multi K+/BlueFree
⊕ Tints	

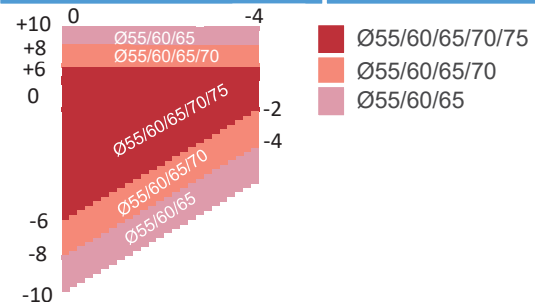

MY SV - Anti Fatigue SV - EzDrive SV

My SV 1.67

⊕ Refractive Index	1.67
⊕ Abbe Value	32
⊕ Coating	HC/Multi/Multi K+/BlueFree
⊕ Tints	Grey/Brown/G15

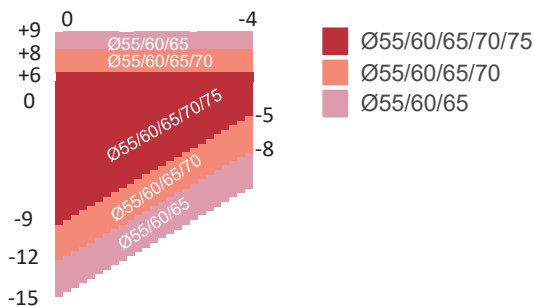

My SV 1.67 Nupolar

⊕ Refractive Index	1.67
⊕ Abbe Value	32
⊕ Coating	HC/Multi/Multi K+/BlueFree
⊕ Polarized Color	Grey/Brown/G15

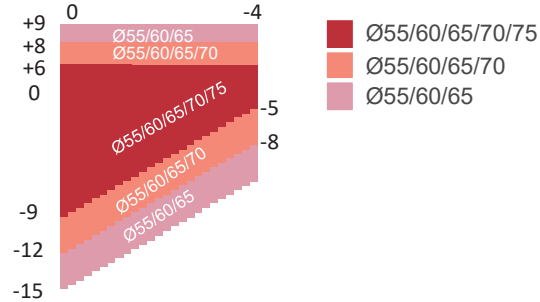

My SV 1.67 PhotoX

⊕ Refractive Index	1.67
⊕ Abbe Value	32
⊕ Coating	HC/Multi/Multi K+/BlueFree
⊕ Photochromic Color	Grey/Brown

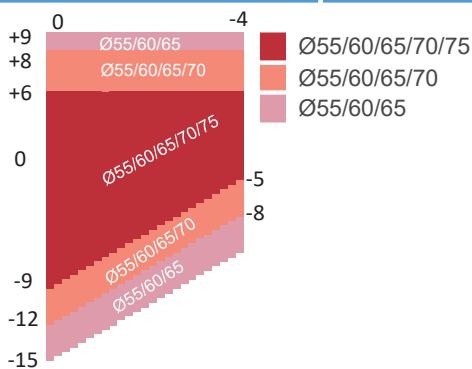

My SV 1.67 Transitions

⊕ Refractive Index	1.67
⊕ Abbe Value	32
⊕ Coating	HC/Multi/Multi K+/BlueFree
⊕ Photochromic Color	Grey/Brown

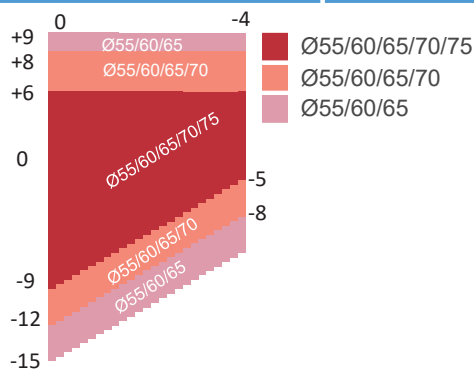

My SV 1.67 UVNeo

⊕ Refractive Index	1.67
⊕ Abbe Value	32
⊕ Coating	HC/Multi/Multi K+/BlueFree
⊕ Tints	

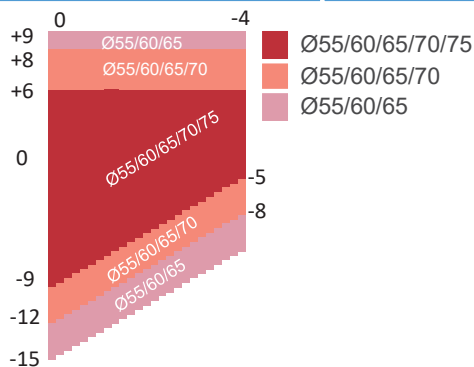

My SV 1.74

⊕ Refractive Index	1.74
⊕ Abbe Value	32
⊕ Coating	Multi/Multi K+/BlueFree
⊕ Tints	

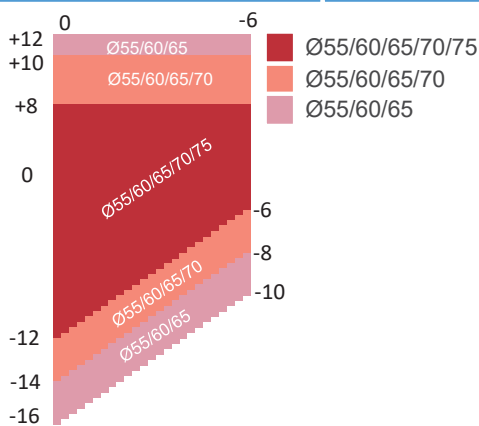

My SV 1.74 Transitions

⊕ Refractive Index	1.74
⊕ Abbe Value	32
⊕ Coating	Multi/Multi K+/BlueFree
⊕ Photochromic Color	Grey/Brown

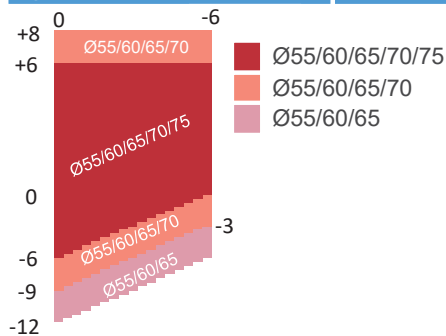

Frezz MOOFX 1.59 Polycarbonate

⊕ Refractive Index	1.59
⊕ Abbe Value	31
⊕ Coating	HC/Multi/Multi K+/BlueFree
⊕ Tints	

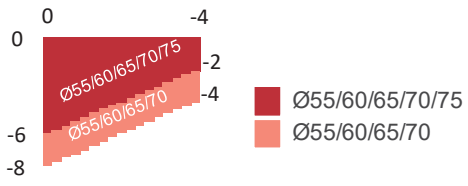

Frezz Standard 1.5

⊕ Coating	HC/Multi/Multi K+/BlueFree
⊕ Tints	Grey/Brown/G15
⊕ Additions:	0.50 to 4.00
⊕ Corridors length:	16,14 and 12mm
⊕ Min recommended FT:	20,18 and 16mm

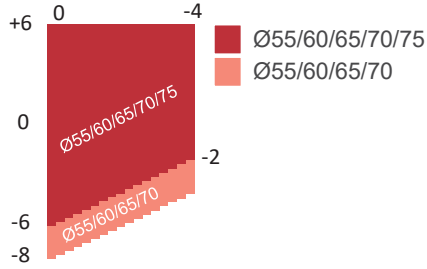

Frezz Standard 1.5 Nupolar

⊕ Coating	HC/Multi/Multi K+/BlueFree
⊕ Polarized Color	Grey/Brown/G15
⊕ Additions:	0.50 to 4.00
⊕ Corridors length:	16,14 and 12mm
⊕ Min recommended FT:	20,18 and 16mm

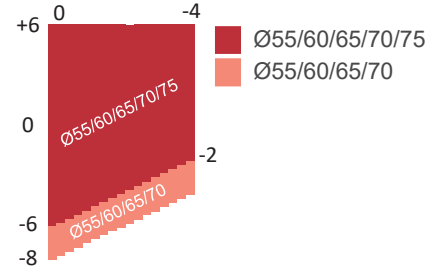

Frezz Standard 1.5 PhotoX

⊕ Coating	HC/Multi/Multi K+/BlueFree
⊕ Photochromic Color	Grey/Brown
⊕ Additions:	0.50 to 4.00
⊕ Corridors length:	16,14 and 12mm
⊕ Min recommended FT:	20,18 and 16mm

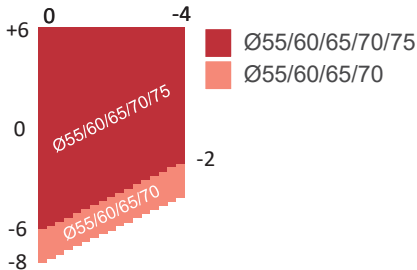

Frezz Standard 1.5 Transitions

⊕ Coating	HC/Multi/Multi K+/BlueFree
⊕ Photochromic Color	Grey/Brown
⊕ Additions:	0.50 to 4.00
⊕ Corridors length:	16,14 and 12mm
⊕ Min recommended FT:	20,18 and 16mm

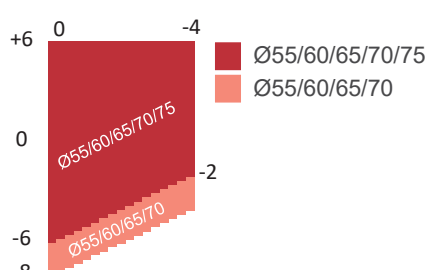

Frezz Standard 1.5 UVNeo

⊕ Coating	HC/Multi/Multi K+/BlueFree
⊕ Tints	
⊕ Additions:	0.50 to 4.00
⊕ Corridors length:	16,14 and 12mm
⊕ Min recommended FT:	20,18 and 16mm

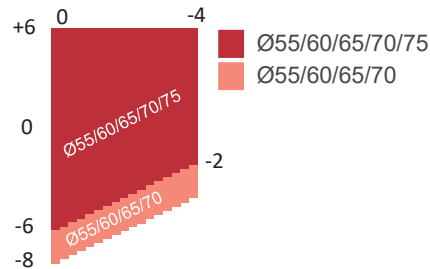

Frezz Standard 1.56

⊕ Coating	HC/Multi/Multi K+/BlueFree
⊕ Tints	Grey/Brown/G15
⊕ Additions:	0.50 to 4.00
⊕ Corridors length:	16,14 and 12mm
⊕ Min recommended FT:	20,18 and 16mm

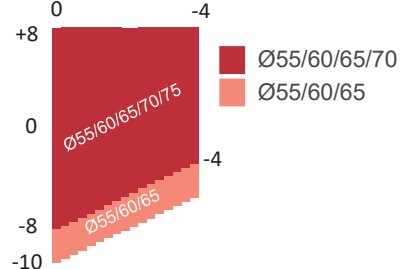

Frezz Standard 1.56 Photochromic

⊕ Coating	HC/Multi/Multi K+/BlueFree
⊕ Photochromic Color	Grey/Brown
⊕ Additions:	0.50 to 4.00
⊕ Corridors length:	16,14 and 12mm
⊕ Min recommended FT:	20,18 and 16mm

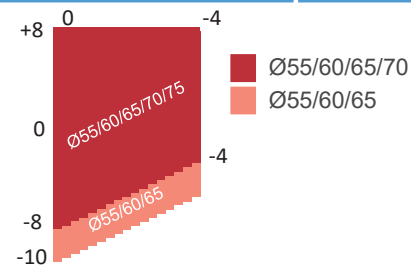

Frezz Standard 1.56 UVNeo

⊕ Coating	HC/Multi/Multi K+/BlueFree
⊕ Tints	
⊕ Additions:	0.50 to 4.00
⊕ Corridors length:	16,14 and 12mm
⊕ Min recommended FT:	20,18 and 16mm

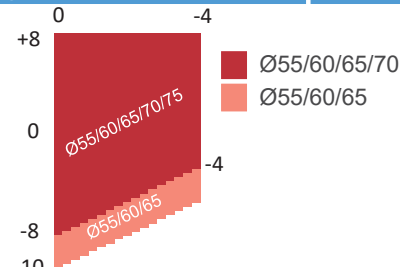

Frezz Standard 1.59 Polycarbonate

⊕ Coating	HC/Multi/Multi K+/BlueFree
⊕ Tints	
⊕ Additions:	0.50 to 4.00
⊕ Corridors length:	16,14 and 12mm
⊕ Min recommended FT:	20,18 and 16mm

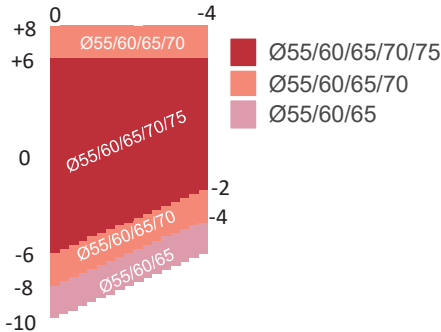

Frezz Standard 1.59 Poly PhotoX

⊕ Coating	HC/Multi/Multi K+/BlueFree
⊕ Photochromic Color	Grey/Brown
⊕ Additions:	0.50 to 4.00
⊕ Corridors length:	16,14 and 12mm
⊕ Min recommended FT:	20,18 and 16mm

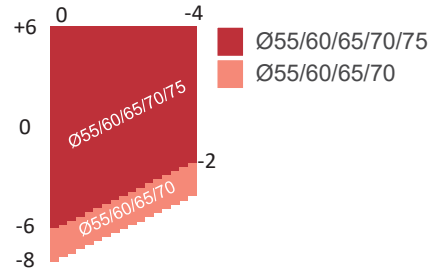

Frezz Standard 1.59 Poly Nupolar

⊕ Coating	HC/Multi/Multi K+/BlueFree
⊕ Polarized Color	Grey/Brown/G15
⊕ Additions:	0.50 to 4.00
⊕ Corridors length:	16,14 and 12mm
⊕ Min recommended FT:	20,18 and 16mm

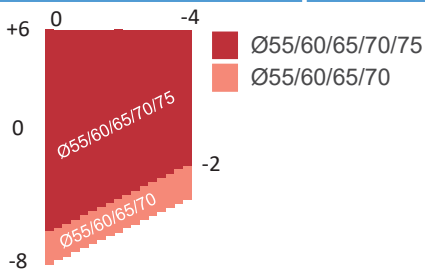

Frezz Standard 1.6

⊕ Coating	HC/Multi/Multi K+/BlueFree
⊕ Tints	Grey/Brown/G15
⊕ Additions:	0.50 to 4.00
⊕ Corridors length:	16,14 and 12mm
⊕ Min recommended FT:	20,18 and 16mm

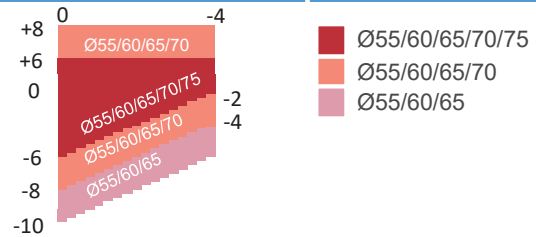

Frezz Standard 1.6 Nupolar

⊕ Coating	HC/Multi/Multi K+/BlueFree
⊕ Polarized Color	Grey/Brown/G15
⊕ Additions:	0.50 to 4.00
⊕ Corridors length:	16,14 and 12mm
⊕ Min recommended FT:	20,18 and 16mm

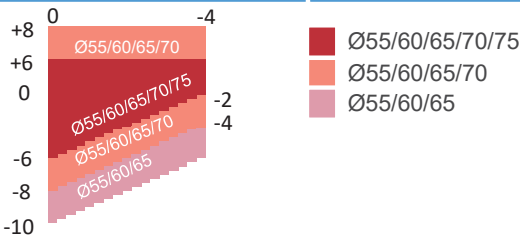

Frezz Standard 1.6 PhotoX

⊕ Coating	HC/Multi/Multi K+/BlueFree
⊕ Photochromic Color	Grey/Brown
⊕ Additions:	0.50 to 4.00
⊕ Corridors length:	16,14 and 12mm
⊕ Min recommended FT:	20,18 and 16mm

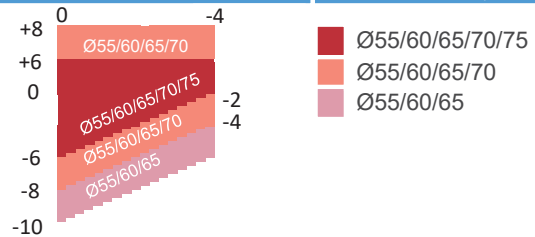

Frezz Standard 1.6 Transitions

⊕ Coating	HC/Multi/Multi K+/BlueFree
⊕ Photochromic Color	Grey/Brown
⊕ Additions:	0.50 to 4.00
⊕ Corridors length:	16,14 and 12mm
⊕ Min recommended FT:	20,18 and 16mm

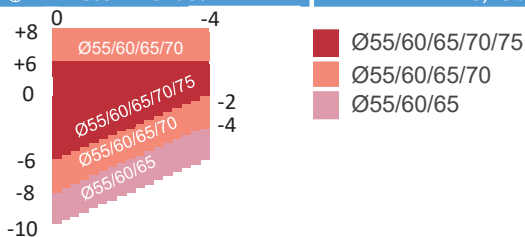

Frezz Standard 1.6 UVNeo

⊕ Coating	HC/Multi/Multi K+/BlueFree
⊕ Photochromic Color	Grey/Brown
⊕ Additions:	0.50 to 4.00
⊕ Corridors length:	16,14 and 12mm
⊕ Min recommended FT:	20,18 and 16mm

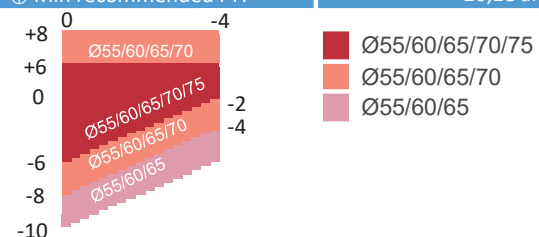

FREZZ Standard - EasyFit - Dynamic - MiniFit - Compo - Reader - EzDrive

Frezz Standard 1.67

⊕ Coating	Multi/Multi K+/BlueFree
⊕ Tints	Grey/Brown/G15
⊕ Additions:	0.50 to 4.00
⊕ Corridors length:	16,14 and 12mm
⊕ Min recommended FT:	20,18 and 16mm

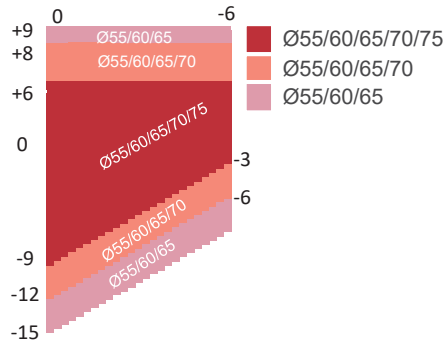

Frezz Standard 1.67 Nupolar

⊕ Coating	Multi/Multi K+/BlueFree
⊕ Polarized Color	Grey/Brown/G15
⊕ Additions:	0.50 to 4.00
⊕ Corridors length:	16,14 and 12mm
⊕ Min recommended FT:	20,18 and 16mm

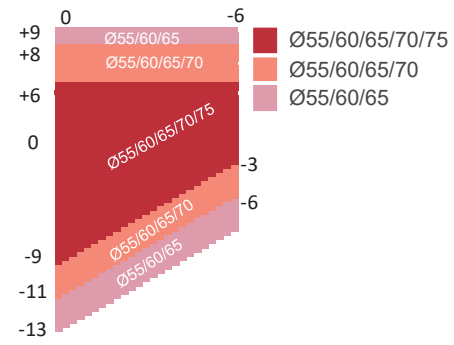

Frezz Standard 1.67 PhotoX

⊕ Coating	Multi/Multi K+/BlueFree
⊕ Photochromic Color	Grey/Brown
⊕ Additions:	0.50 to 4.00
⊕ Corridors length:	16,14 and 12mm
⊕ Min recommended FT:	20,18 and 16mm

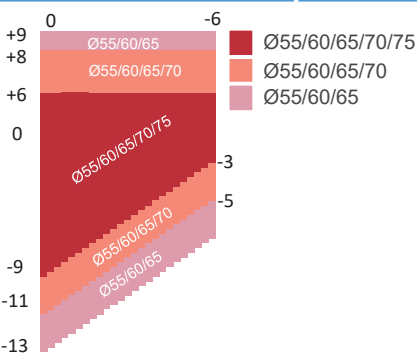

Frezz Standard 1.67 Transitions

⊕ Coating	Multi/Multi K+/BlueFree
⊕ Photochromic Color	Grey/Brown
⊕ Additions:	0.50 to 4.00
⊕ Corridors length:	16,14 and 12mm
⊕ Min recommended FT:	20,18 and 16mm

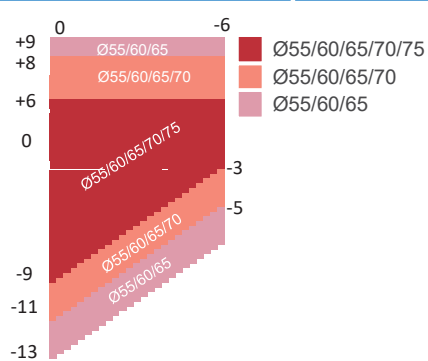

Frezz Standard 1.67 UVNeo

⊕ Coating	Multi/Multi K+/BlueFree
⊕ Tints	
⊕ Additions:	0.50 to 4.00
⊕ Corridors length:	16,14 and 12mm
⊕ Min recommended FT:	20,18 and 16mm

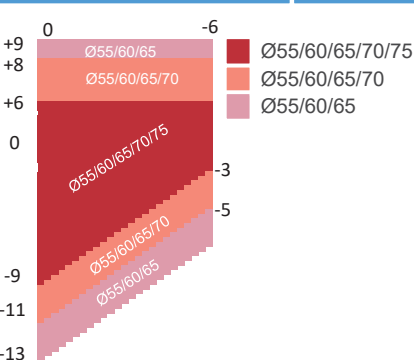

Frezz Standard 1.74

⊕ Coating	Multi/Multi K+/BlueFree
⊕ Tints	
⊕ Additions:	0.50 to 4.00
⊕ Corridors length:	16,14 and 12mm
⊕ Min recommended FT:	20,18 and 16mm

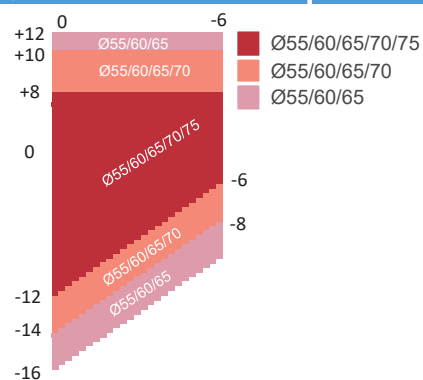

Frezz Standard 1.74 Transitions

⊕ Coating	Multi/Multi K+/BlueFree
⊕ Photochromic Color	Grey/Brown
⊕ Additions:	0.50 to 4.00
⊕ Corridors length:	16,14 and 12mm
⊕ Min recommended FT:	20,18 and 16mm

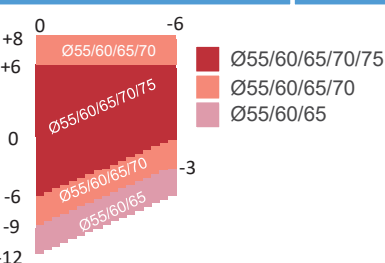

FREZZ Nature

Frezz Nature 1.5

⊕ Coating	HC/Multi/Multi K+/BlueFree
⊕ Tints	Grey/Brown/G15
⊕ Additions:	0.50 to 4.00
⊕ Corridors length:	16,15,14,13,12,11,10
⊕ Min recommended FT:	20,19,18,17,16,15,14

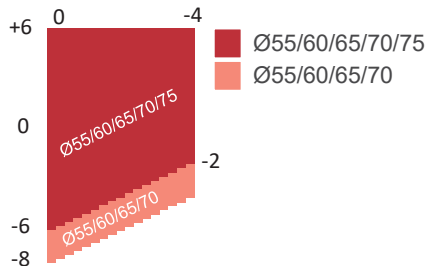

Frezz Nature 1.5 Nupolar

⊕ Coating	HC/Multi/Multi K+/BlueFree
⊕ Polarized Color	Grey/Brown/G15
⊕ Additions:	0.50 to 4.00
⊕ Corridors length:	16,15,14,13,12,11,10
⊕ Min recommended FT:	20,19,18,17,16,15,14

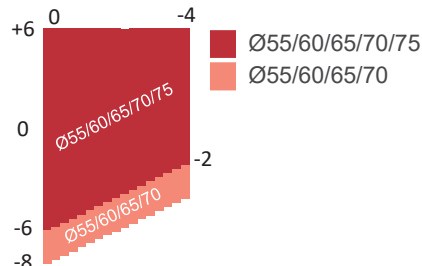

Frezz Nature 1.5 PhotoX

⊕ Coating	HC/Multi/Multi K+/BlueFree
⊕ Photochromic Color	Grey/Brown
⊕ Additions:	0.50 to 4.00
⊕ Corridors length:	16,15,14,13,12,11,10
⊕ Min recommended FT:	20,19,18,17,16,15,14

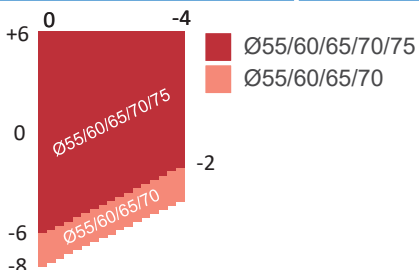

Frezz Nature 1.5 Transitions

⊕ Coating	HC/Multi/Multi K+/BlueFree
⊕ Photochromic Color	Grey/Brown
⊕ Additions:	0.50 to 4.00
⊕ Corridors length:	16,15,14,13,12,11,10
⊕ Min recommended FT:	20,19,18,17,16,15,14

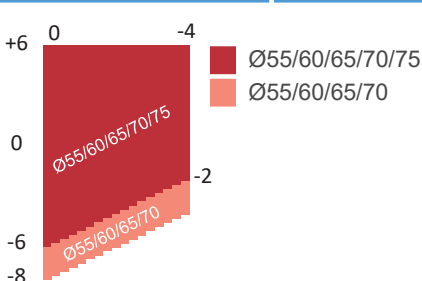

Frezz Nature 1.5 UVNeo

⊕ Coating	HC/Multi/Multi K+/BlueFree
⊕ Tints	Grey/Brown/G15
⊕ Additions:	0.50 to 4.00
⊕ Corridors length:	16,15,14,13,12,11,10
⊕ Min recommended FT:	20,19,18,17,16,15,14

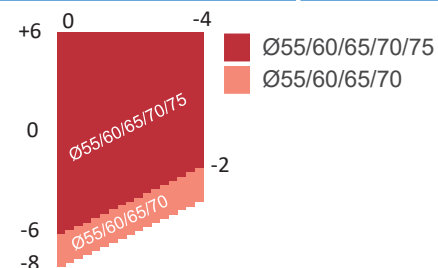

Frezz Nature 1.56

⊕ Coating	HC/Multi/Multi K+/BlueFree
⊕ Tints	Grey/Brown/G15
⊕ Additions:	0.50 to 4.00
⊕ Corridors length:	16,15,14,13,12,11,10
⊕ Min recommended FT:	20,19,18,17,16,15,14

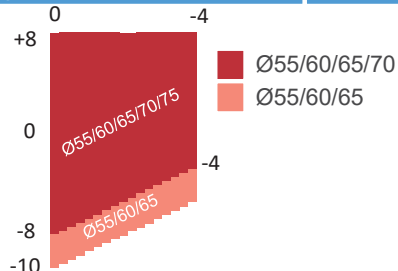

Frezz Nature 1.56 Photochromic

⊕ Coating	HC/Multi/Multi K+/BlueFree
⊕ Photochromic Color	Grey/Brown
⊕ Additions:	0.50 to 4.00
⊕ Corridors length:	16,15,14,13,12,11,10
⊕ Min recommended FT:	20,19,18,17,16,15,14

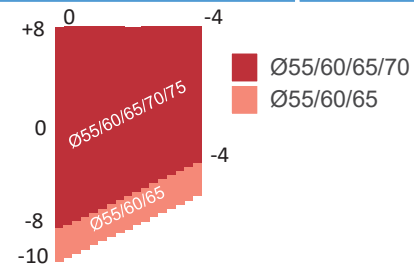

Frezz Nature 1.56 UVNeo

⊕ Coating	HC/Multi/Multi K+/BlueFree
⊕ Tints	Grey/Brown/G15
⊕ Additions:	0.50 to 4.00
⊕ Corridors length:	16,15,14,13,12,11,10
⊕ Min recommended FT:	20,19,18,17,16,15,14

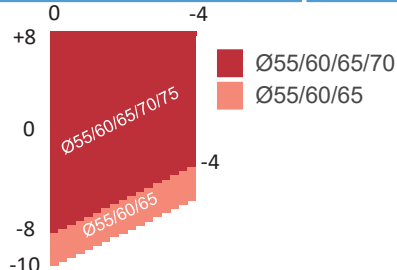

Frezz Nature 1.59 Polycarbonate

⊕ Coating	HC/Multi/Multi K+/BlueFree
⊕ Tints	
⊕ Additions:	0.50 to 4.00
⊕ Corridors length:	16,15,14,13,12,11,10
⊕ Min recommended FT:	20,19,18,17,16,15,14

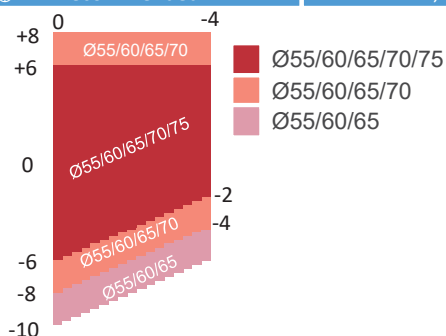

Frezz Nature 1.59 Poly PhotoX

⊕ Coating	HC/Multi/Multi K+/BlueFree
⊕ Photochromic Color	Grey/Brown
⊕ Additions:	0.50 to 4.00
⊕ Corridors length:	16,15,14,13,12,11,10
⊕ Min recommended FT:	20,19,18,17,16,15,14

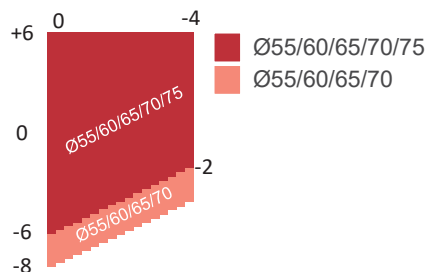

Frezz Nature 1.59 Poly Nupolar

⊕ Coating	HC/Multi/Multi K+/BlueFree
⊕ Polarized Color	Grey/Brown/G15
⊕ Additions:	0.50 to 4.00
⊕ Corridors length:	16,15,14,13,12,11,10
⊕ Min recommended FT:	20,19,18,17,16,15,14

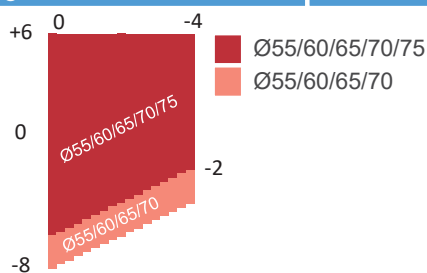

Frezz Nature 1.6

⊕ Coating	HC/Multi/Multi K+/BlueFree
⊕ Tints	Grey/Brown/G15
⊕ Additions:	0.50 to 4.00
⊕ Corridors length:	16,15,14,13,12,11,10
⊕ Min recommended FT:	20,19,18,17,16,15,14

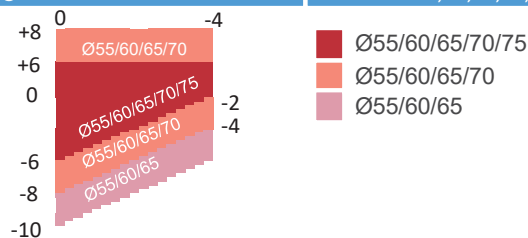

Frezz Nature 1.6 Nupolar

⊕ Coating	HC/Multi/Multi K+/BlueFree
⊕ Polarized Color	Grey/Brown/G15
⊕ Additions:	0.50 to 4.00
⊕ Corridors length:	16,15,14,13,12,11,10
⊕ Min recommended FT:	20,19,18,17,16,15,14

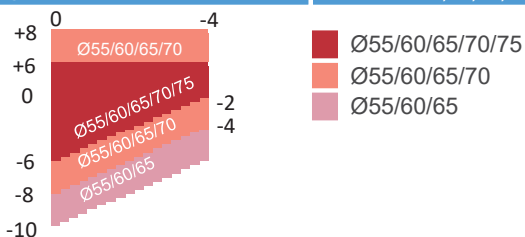

Frezz Nature 1.6 PhotoX

⊕ Coating	HC/Multi/Multi K+/BlueFree
⊕ Photochromic Color	Grey/Brown
⊕ Additions:	0.50 to 4.00
⊕ Corridors length:	16,15,14,13,12,11,10
⊕ Min recommended FT:	20,19,18,17,16,15,14

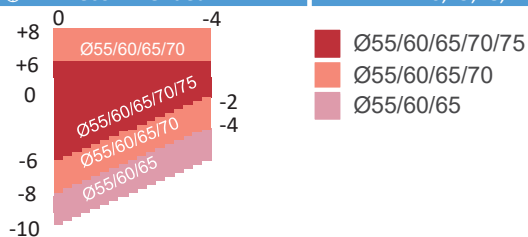

Frezz Nature 1.6 Transitions

⊕ Coating	HC/Multi/Multi K+/BlueFree
⊕ Photochromic Color	Grey/Brown
⊕ Additions:	0.50 to 4.00
⊕ Corridors length:	16,15,14,13,12,11,10
⊕ Min recommended FT:	20,19,18,17,16,15,14

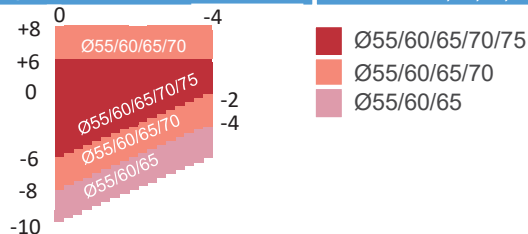

Frezz Nature 1.6 UVNeo

⊕ Coating	HC/Multi/Multi K+/BlueFree
⊕ Photochromic Color	Grey/Brown
⊕ Additions:	0.50 to 4.00
⊕ Corridors length:	16,15,14,13,12,11,10
⊕ Min recommended FT:	20,19,18,17,16,15,14

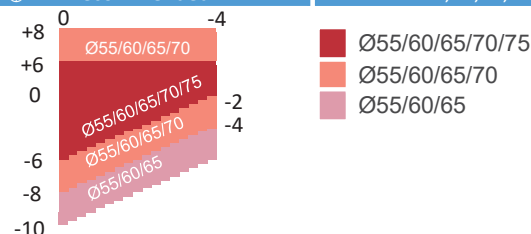

Frezz Nature 1.67

⊕ Coating	Multi/Multi K+/BlueFree
⊕ Tints	Grey/Brown/G15
⊕ Additions:	0.50 to 4.00
⊕ Corridors length:	16,15,14,13,12,11,10
⊕ Min recommended FT:	20,19,18,17,16,15,14

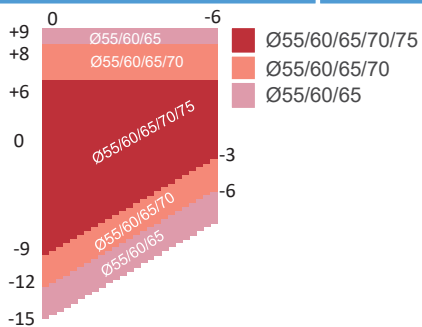

Frezz Nature 1.67 Nupolar

⊕ Coating	Multi/Multi K+/BlueFree
⊕ Polarized Color	Grey/Brown/G15
⊕ Additions:	0.50 to 4.00
⊕ Corridors length:	16,15,14,13,12,11,10
⊕ Min recommended FT:	20,19,18,17,16,15,14

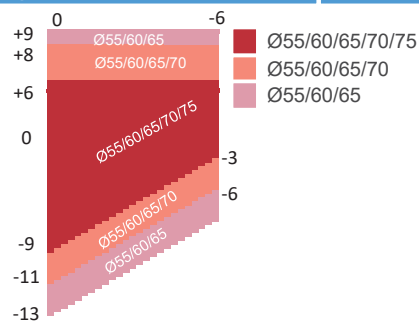

Frezz Nature 1.67 PhotoX

⊕ Coating	Multi/Multi K+/BlueFree
⊕ Photochromic Color	Grey/Brown
⊕ Additions:	0.50 to 4.00
⊕ Corridors length:	16,15,14,13,12,11,10
⊕ Min recommended FT:	20,19,18,17,16,15,14

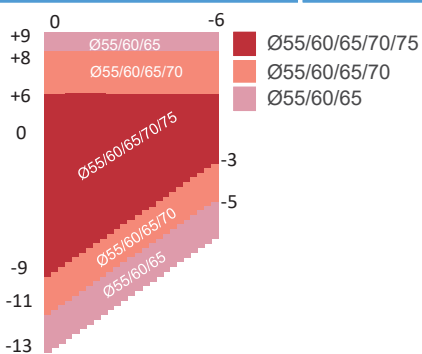

Frezz Nature 1.67 Transitions

⊕ Coating	Multi/Multi K+/BlueFree
⊕ Photochromic Color	Grey/Brown
⊕ Additions:	0.50 to 4.00
⊕ Corridors length:	16,15,14,13,12,11,10
⊕ Min recommended FT:	20,19,18,17,16,15,14

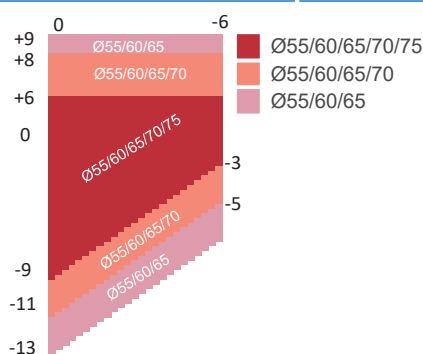

Frezz Nature 1.67 UVNeo

⊕ Coating	Multi/Multi K+/BlueFree
⊕ Photochromic Color	Grey/Brown
⊕ Additions:	0.50 to 4.00
⊕ Corridors length:	16,15,14,13,12,11,10
⊕ Min recommended FT:	20,19,18,17,16,15,14

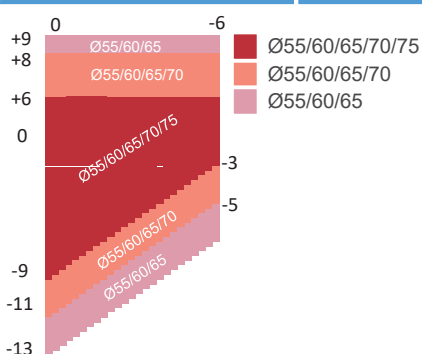

Frezz Nature 1.74

⊕ Coating	Multi/Multi K+/BlueFree
⊕ Tints	
⊕ Additions:	0.50 to 4.00
⊕ Corridors length:	16,15,14,13,12,11,10
⊕ Min recommended FT:	20,19,18,17,16,15,14

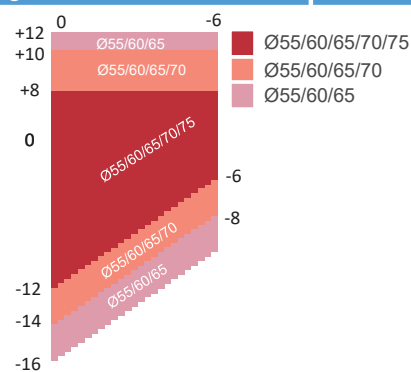

Frezz Nature 1.74 Transitions

⊕ Coating	Multi/Multi K+/BlueFree
⊕ Photochromic Color	Grey/Brown
⊕ Additions:	0.50 to 4.00
⊕ Corridors length:	16,15,14,13,12,11,10
⊕ Min recommended FT:	20,19,18,17,16,15,14

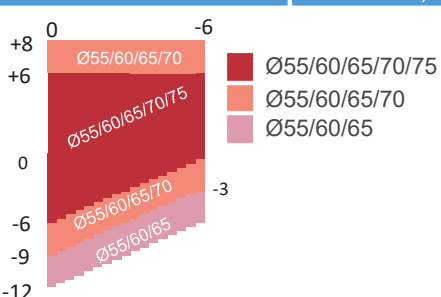

FREZZ OptiMixerDS

Frezz OptiMixerDS 1.5

⊕ Coating	HC/Multi/Multi K+/BlueFree
⊕ Tints	Grey/Brown/G15
⊕ Additions:	0.50 to 4.00
⊕ Corridors length:	16,15,14,13,12,11,10
⊕ Min recommended FT:	20,19,18,17,16,15,14

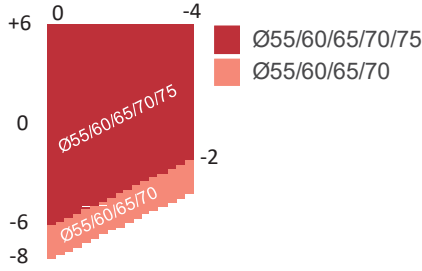

Frezz OptiMixerDS 1.5 PhotoX

⊕ Coating	HC/Multi/Multi K+/BlueFree
⊕ Photochromic Color	Grey/Brown
⊕ Additions:	0.50 to 4.00
⊕ Corridors length:	16,15,14,13,12,11,10
⊕ Min recommended FT:	20,19,18,17,16,15,14

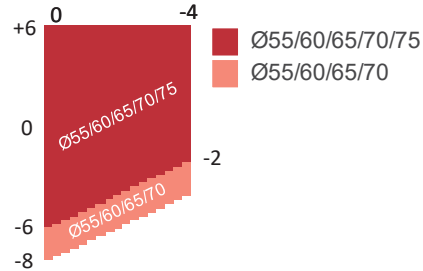

Frezz OptiMixerDS 1.6

⊕ Coating	HC/Multi/Multi K+/BlueFree
⊕ Tints	Grey/Brown/G15
⊕ Additions:	0.50 to 4.00
⊕ Corridors length:	16,15,14,13,12,11,10
⊕ Min recommended FT:	20,19,18,17,16,15,14

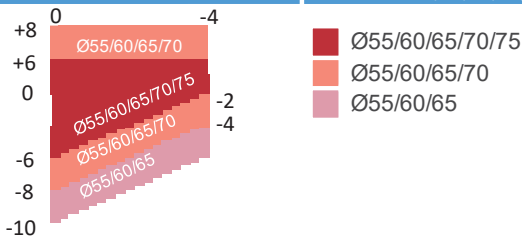

Frezz OptiMixerDS 1.6 PhotoX

⊕ Coating	HC/Multi/Multi K+/BlueFree
⊕ Photochromic Color	Gery/Brown
⊕ Additions:	0.50 to 4.00
⊕ Corridors length:	16,15,14,13,12,11,10
⊕ Min recommended FT:	20,19,18,17,16,15,14

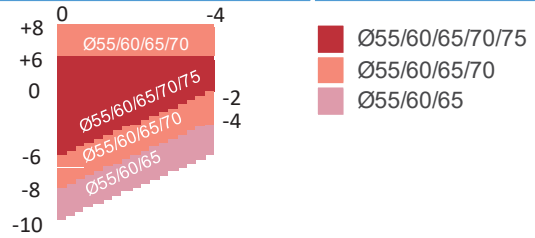

Frezz OptiMixerDS 1.67

⊕ Coating	Multi/Multi K+/BlueFree
⊕ Tints	Grey/Brown/G15
⊕ Additions:	0.50 to 4.00
⊕ Corridors length:	16,15,14,13,12,11,10
⊕ Min recommended FT:	20,19,18,17,16,15,14

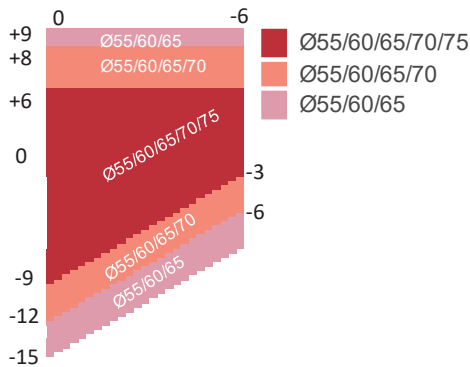

Frezz OptiMixerDS 1.67 PhotoX

⊕ Coating	Multi/Multi K+/BlueFree
⊕ Photochromic Color	Grey/Brown
⊕ Additions:	0.50 to 4.00
⊕ Corridors length:	16,15,14,13,12,11,10
⊕ Min recommended FT:	20,19,18,17,16,15,14

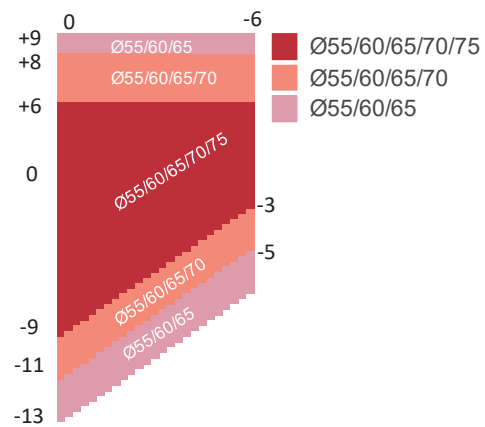

Frezz OptiMixerDS 1.74

⊕ Coating	Multi/Multi K+/BlueFree
⊕ Tints	
⊕ Additions:	0.50 to 4.00
⊕ Corridors length:	16,15,14,13,12,11,10
⊕ Min recommended FT:	20,19,18,17,16,15,14

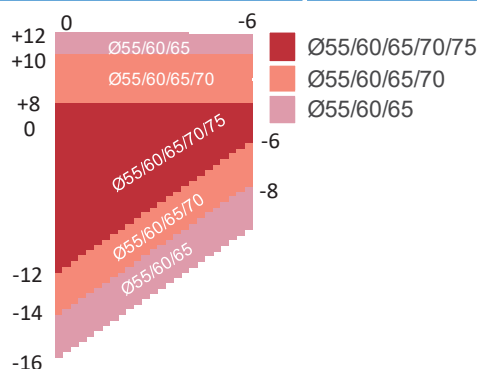

FREZZ Bifocal Meta - Bifocal Freeround

Frezz Bifocal Meta 1.5

⊕ Coating	HC/Multi/Multi K+/BlueFree
⊕ Tints	Grey/Brown/G15
⊕ Additions:	0.50 to 4.00
⊕ Corridors length:	
⊕ Min recommended FT:	

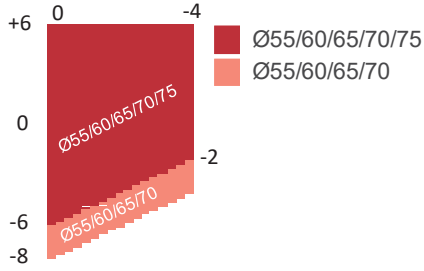

Frezz Bifocal Meta 1.5 PhotoX

⊕ Coating	HC/Multi/Multi K+/BlueFree
⊕ Photochromic Color	Grey/Brown
⊕ Additions:	0.50 to 4.00
⊕ Corridors length:	
⊕ Min recommended FT:	

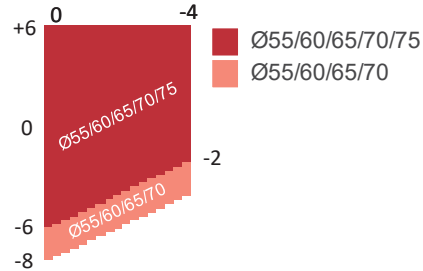

Frezz Bifocal Meta 1.6

⊕ Coating	HC/Multi/Multi K+/BlueFree
⊕ Tints	Grey/Brown/G15
⊕ Additions:	0.50 to 4.00
⊕ Corridors length:	
⊕ Min recommended FT:	

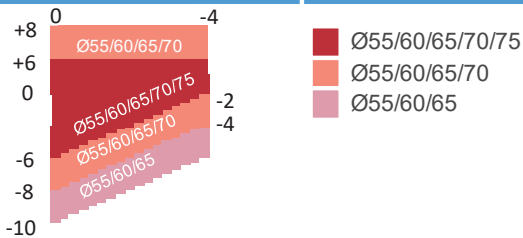

Frezz Bifocal Meta 1.6 PhotoX

⊕ Coating	HC/Multi/Multi K+/BlueFree
⊕ Photochromic Color	Gery/Brown
⊕ Additions:	0.50 to 4.00
⊕ Corridors length:	
⊕ Min recommended FT:	

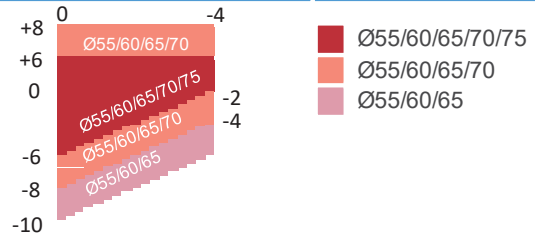

Frezz Bifocal Meta 1.67

⊕ Coating	Multi/Multi K+/BlueFree
⊕ Tints	Grey/Brown/G15
⊕ Additions:	0.50 to 4.00
⊕ Corridors length:	
⊕ Min recommended FT:	

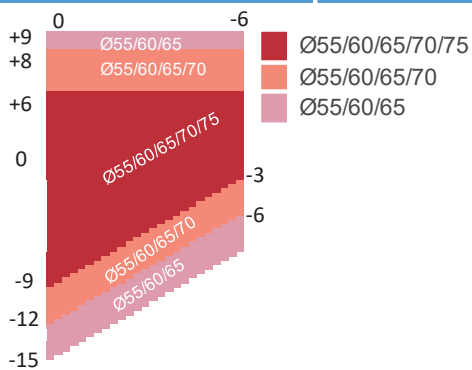

Frezz Bifocal Meta 1.67 PhotoX

⊕ Coating	Multi/Multi K+/BlueFree
⊕ Photochromic Color	Grey/Brown
⊕ Additions:	0.50 to 4.00
⊕ Corridors length:	
⊕ Min recommended FT:	

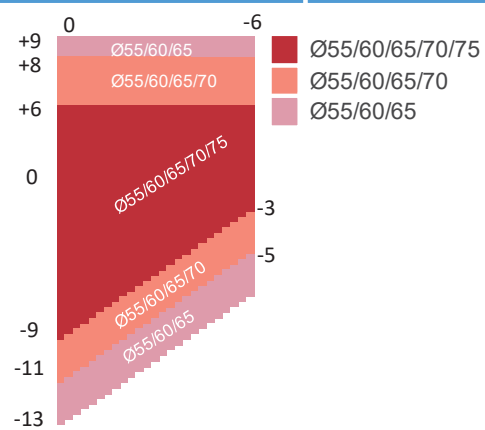

Frezz Bifocal Meta 1.74

⊕ Coating	Multi/Multi K+/BlueFree
⊕ Tints	
⊕ Additions:	0.50 to 4.00
⊕ Corridors length:	
⊕ Min recommended FT:	

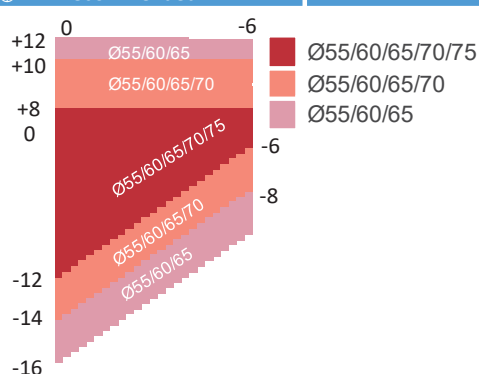

VEGAHD Class 1.5

⊕ Coating	HC/Multi/Multi K+/BlueFree
⊕ Tints	Grey/Brown/G15
⊕ Additions:	1.00 to 3.50
⊕ Corridors length:	15mm
⊕ Min recommended FT:	19mm

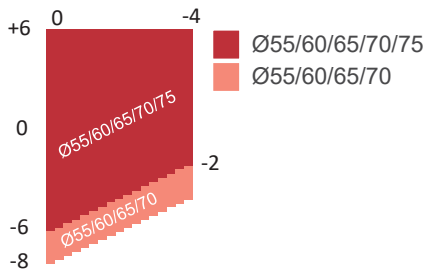

VEGAHD Short 1.5

⊕ Coating	HC/Multi/Multi K+/BlueFree
⊕ Tints	Grey/Brown
⊕ Additions:	1.00 to 3.50
⊕ Corridors length:	12mm
⊕ Min recommended FT:	15mm

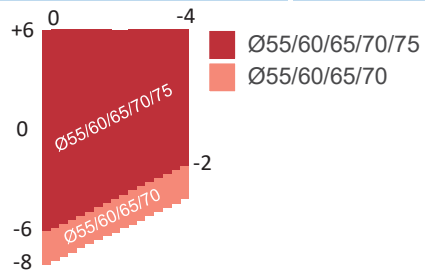

VEGAHD Evolution 1.6 MR-8

⊕ Coating	HC/Multi/Multi K+/BlueFree
⊕ Additions:	1.00 to 3.50
⊕ Corridors length:	15mm
⊕ Min recommended FT:	19mm

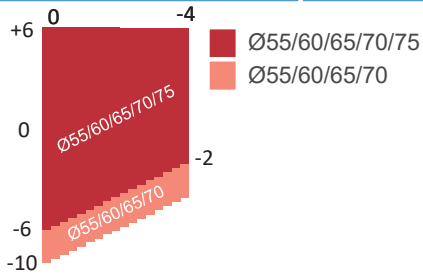

Bifocal FT RX 1.5

⊕ Coating	HC/Multi/Multi K+
⊕ Additions:	1.00 to 3.00
⊕ Min recommended FT:	14mm

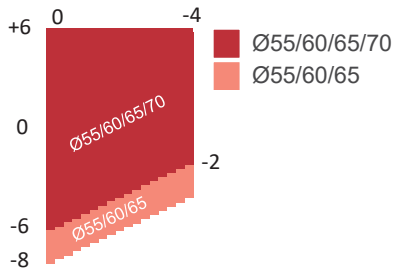

Bifocal FT RX 1.56

⊕ Coating	HC/Multi/Multi K+
⊕ Additions:	1.00 to 3.00
⊕ Min recommended FT:	14mm

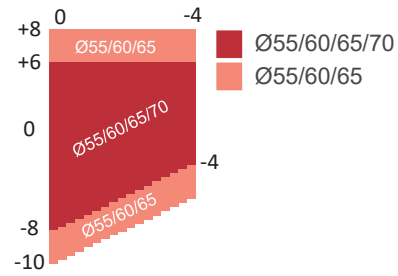

Bifocal FT RX 1.56 Photochromic

⊕ Coating	HC/Multi/Multi K+
⊕ Additions:	1.00 to 3.00
⊕ Min recommended FT:	14mm

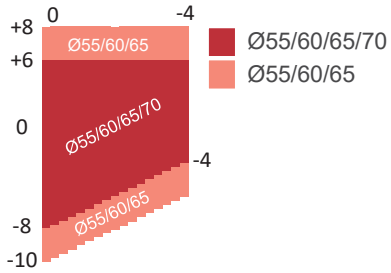

Bifocal FT RX 1.59 Polycarbonate

⊕ Coating	HC/Multi/Multi K+
⊕ Additions:	1.00 to 3.00
⊕ Min recommended FT:	14mm

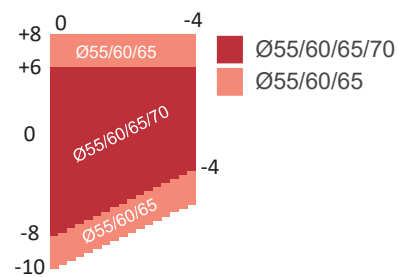

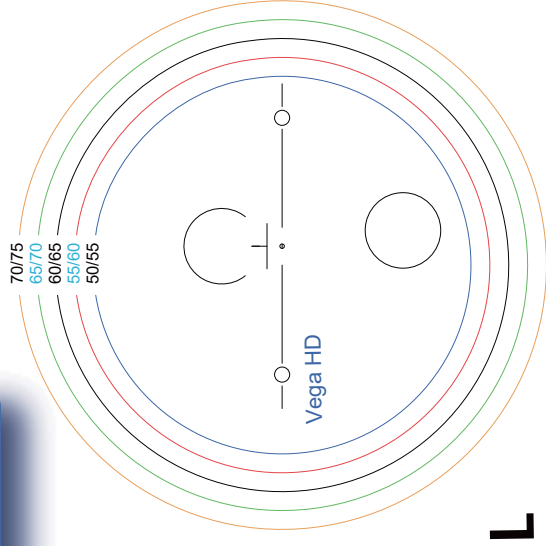

L

VEGAHD Classic/Evolution

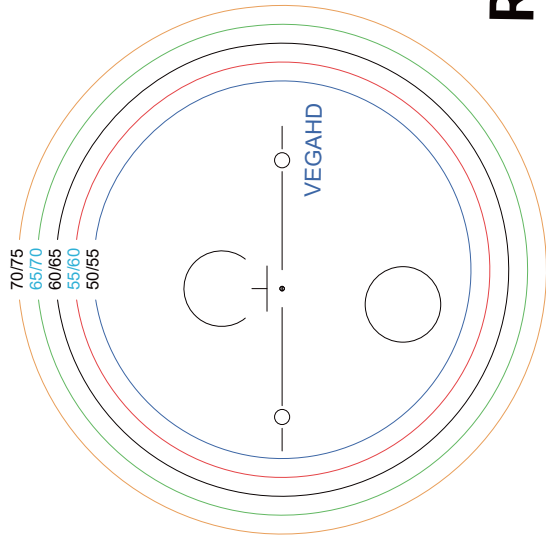
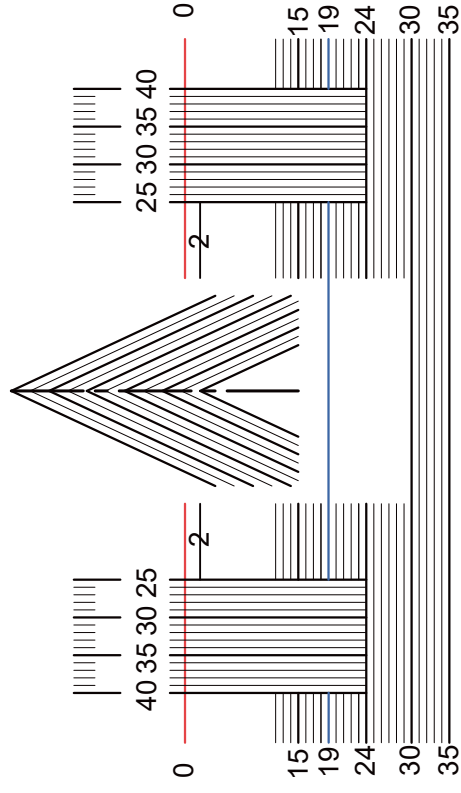

R

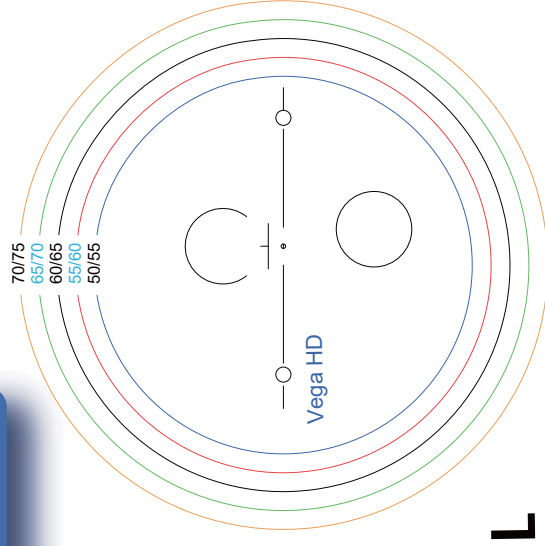

L

VEGAHD Short

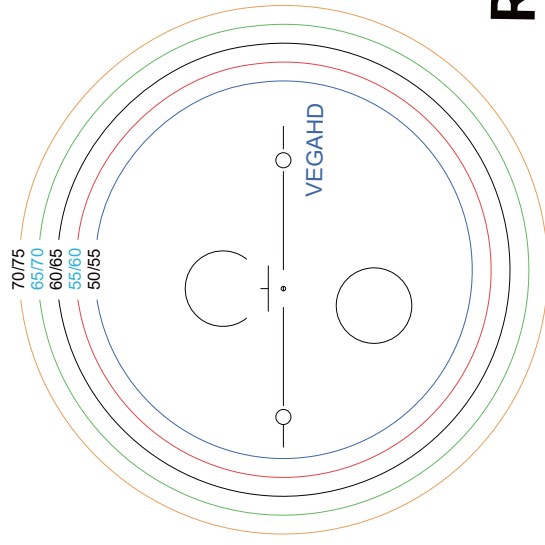
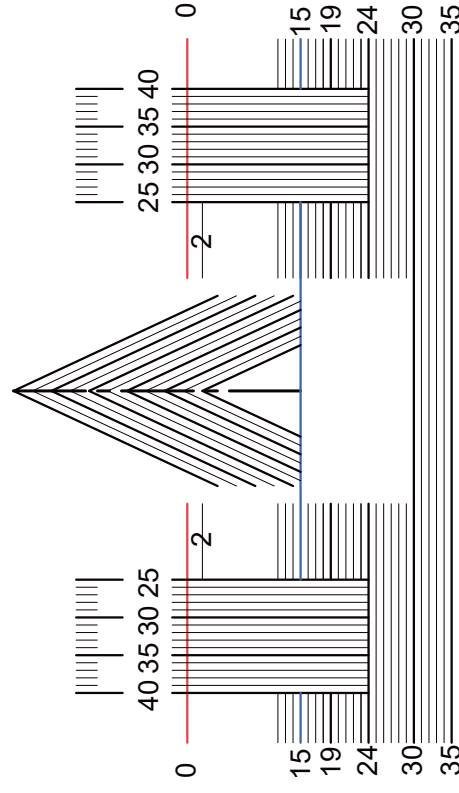

R

FREZZ Standard

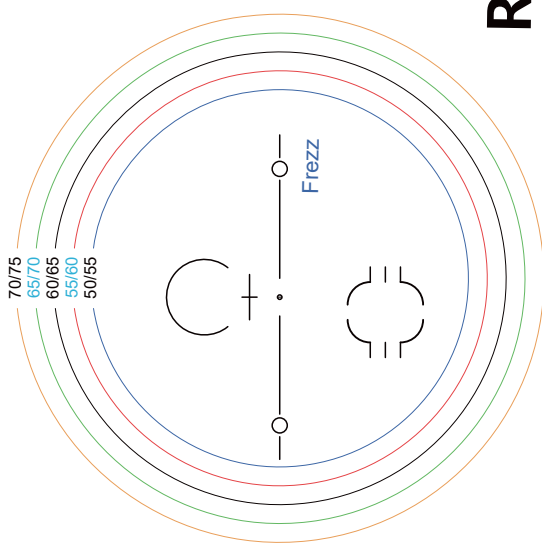
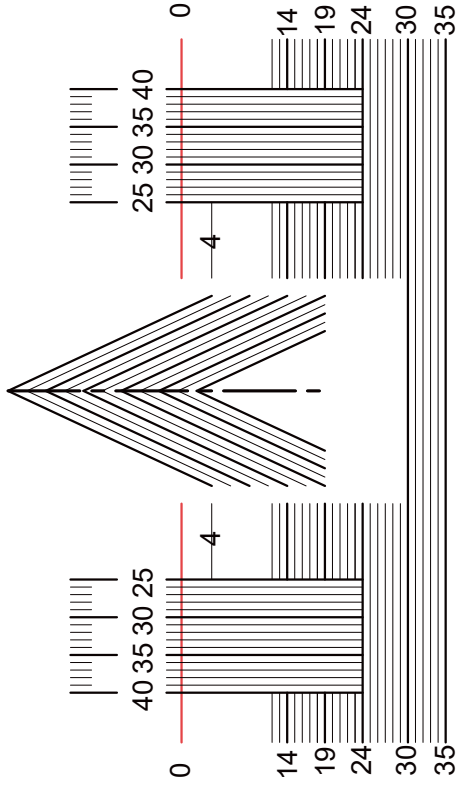
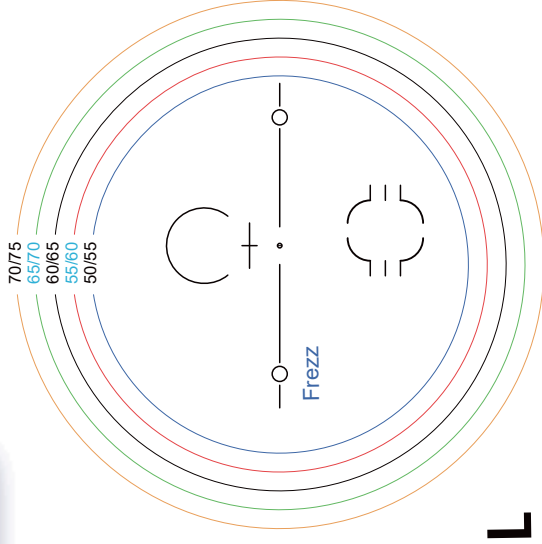

L

R

FREZZ EasyFit/Dynamic/Compo/Nature/EzDrive

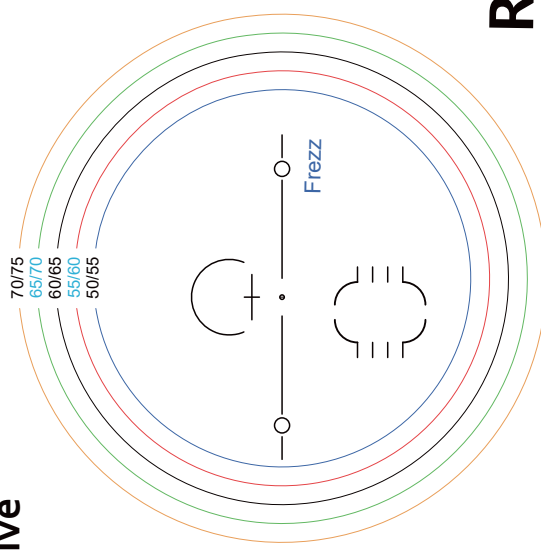
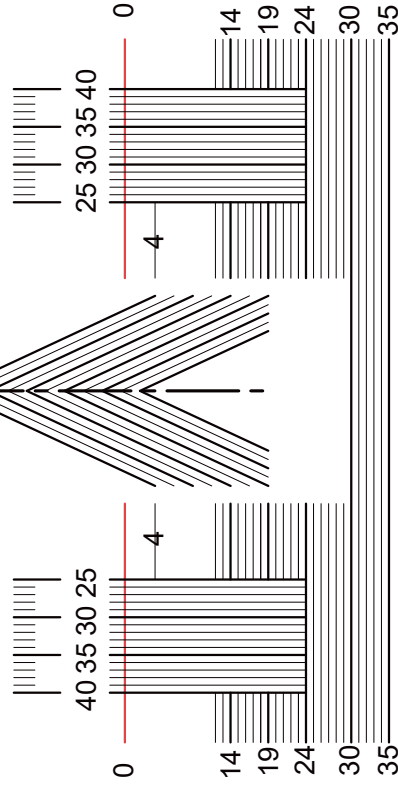
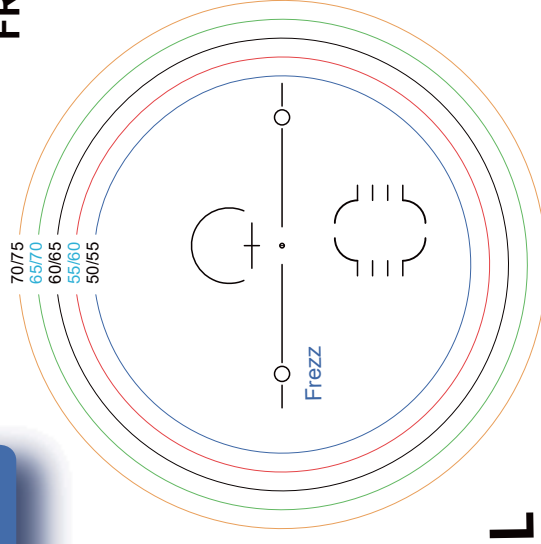

L

R

FREZZ MiniFit

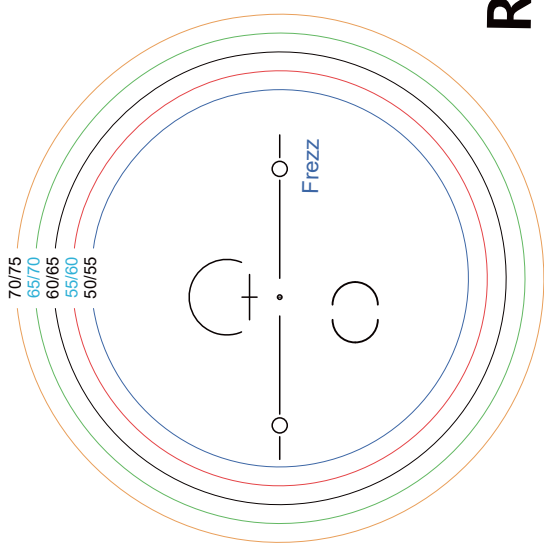
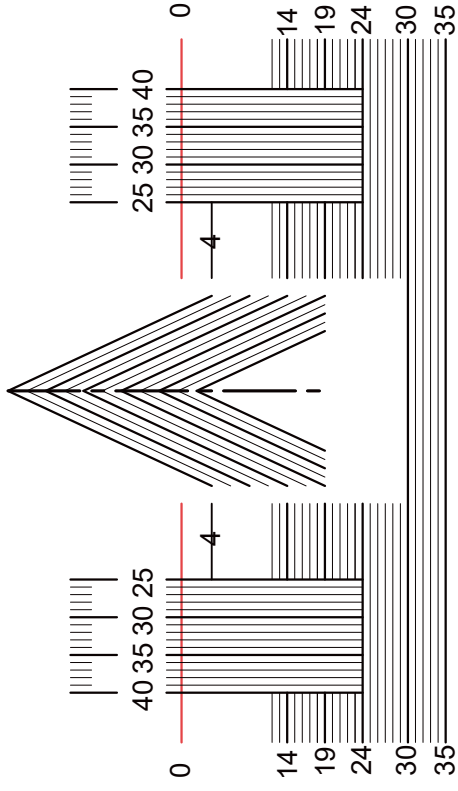
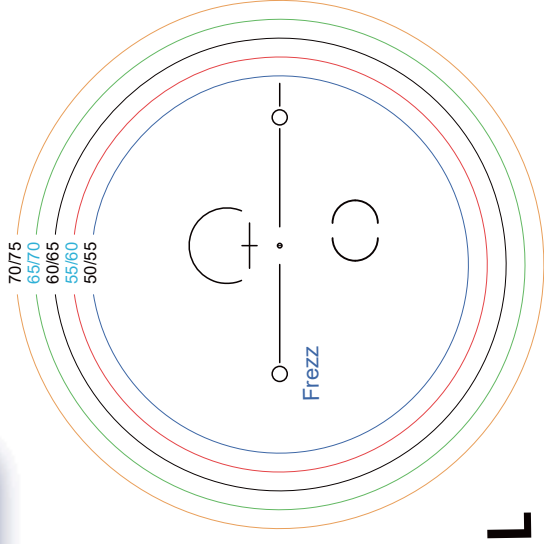

L

R

FREZZ Reader

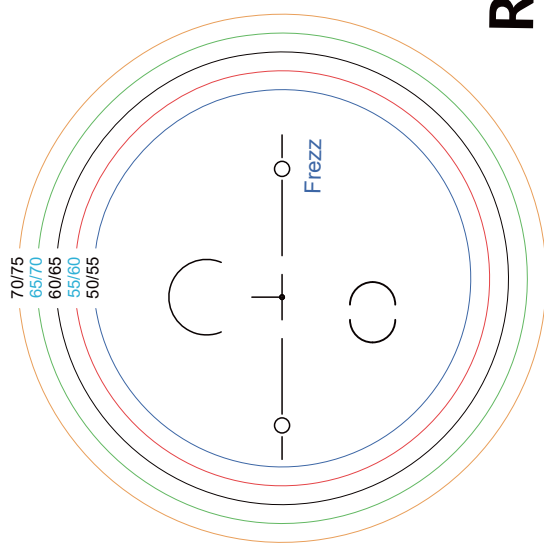
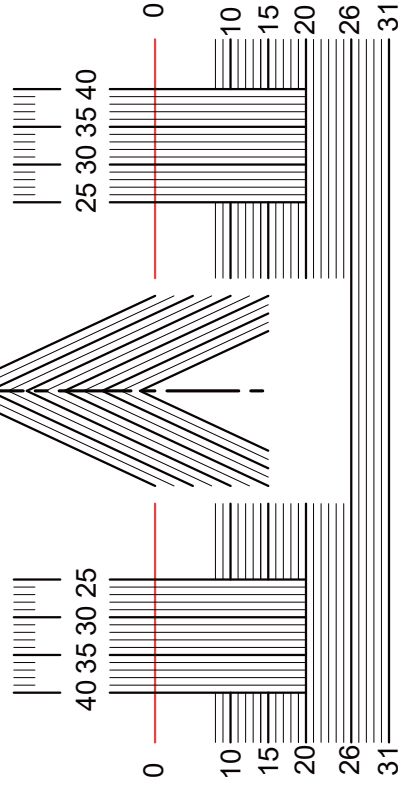
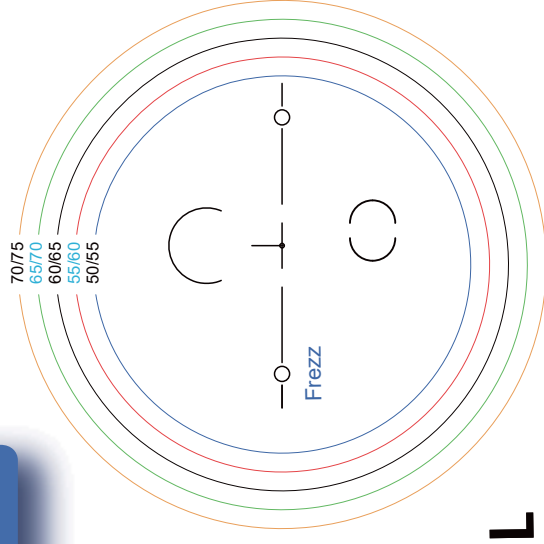

L

R

GINO OPTICAL

PRODUCTION LOCATIONS

GINO OPTICAL PUDONG, SHANGHAI, CHINA

GINO OPTICAL LAT KRABANG, BANGKOK, THAILAND

VERBAL TREMBLAY-EN-FRANCE, FRANCE

CONTACT INFO

NO. 800, QINGDAI ROAD, PUDONG SHANGHAI, CHINA

Email: info@ginoptic.com

www.ginoptic.com